

Automatic oil circulation lubrication systems

Product catalogue 2023

INCL.
THE UPDATED
FLOWLINE OIL
SUPPLY
UNIT

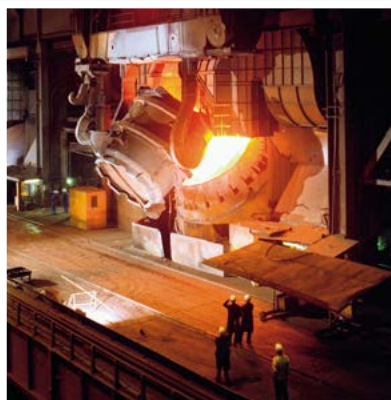
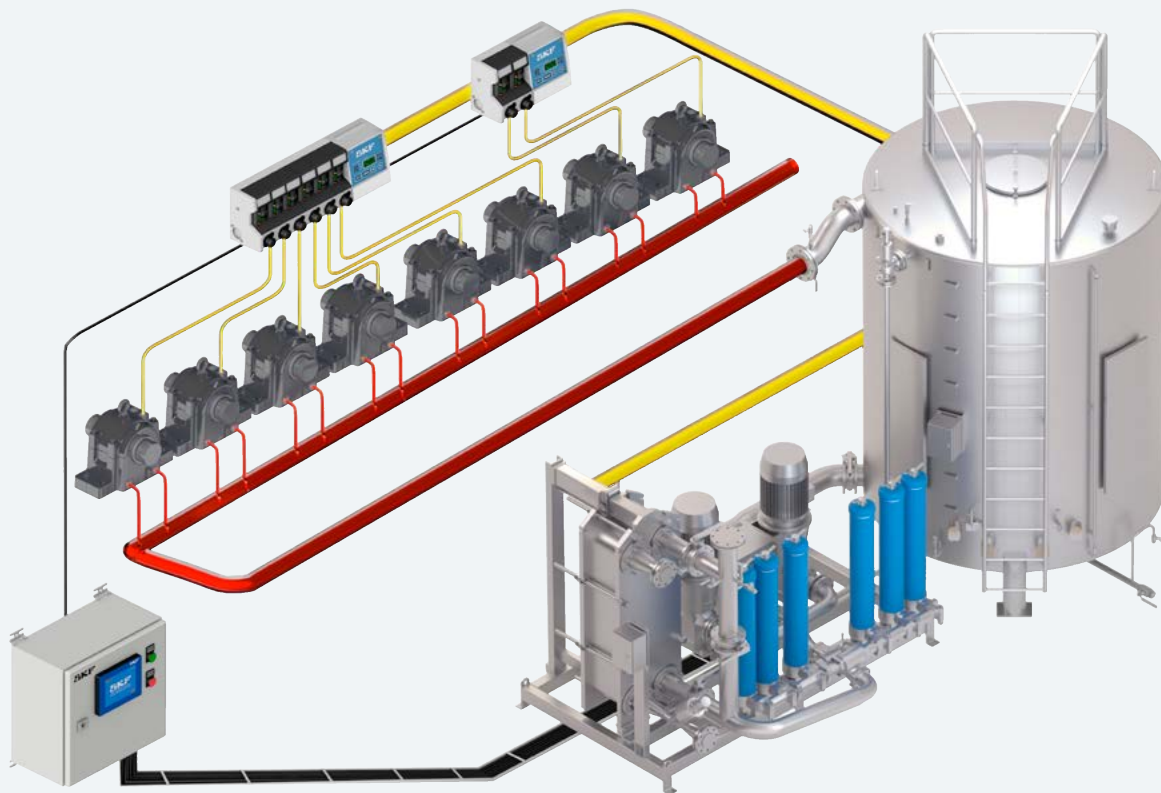

Table of contents

Electronic part library	4	Overview of oil circulation metering devices	43
System description	6	VD	46
System advantages	7	SMT	48
Applications	7	242	50
Recommended product combinations	8	SKF Variolub	52
System component highlights	9	SKF Safeflow	54
Overview of oil circulation supply units	11	SKF Flowline Monitor	56
MF	12	SMBM-X (Single-flow)	58
FLMF	14	SMBM-V (Dual-flow)	60
SM	16	SMB 3	62
OCU	18	SMB 13	64
Flowline	20	SMB 6	66
Streamline	22	SMB 14	68
Overview of oil circulation pumps	25	PSG1	70
M/MF	26	PSG2	72
FLM/FLMF	28	PSG3	74
ZP	30	VP	76
ZM (single-circuit)	32	Overview of oil circulation control units and software	79
143 without motor	34	ST-2240-CIRC	80
143 with motor	36	SKF Flowline Software	81
ZM (multi-circuit)	38	Overview of oil circulation monitoring devices	83
ZPU 09/09A	40	WS 32/33/35	84
		WS63-2	86
		WS68	87
		171-210	88
		SFZM	90
		SFZ	92
		IPM	94
		Overview of oil circulation system accessories	97
		169-460-...	98
		Index	100

Navigation

Introduction	4
Oil supply units	11
Pumps	25
Metering devices	43
Control units	79
Monitoring devices	83
Accessories	97

Electronic part library

CAD product data

Introduction

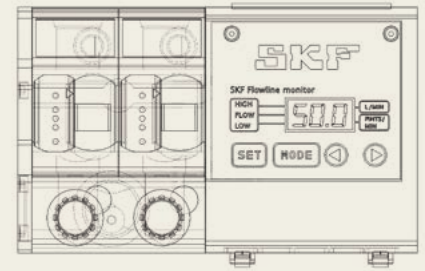
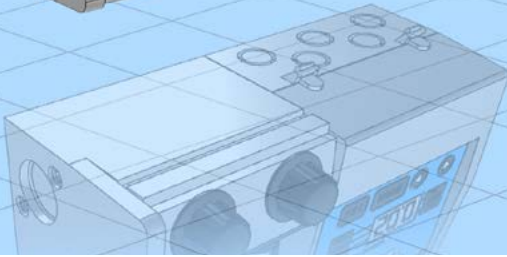

Find your parts online

3D CAD data, technical drawings and data sheets of SKF automatic lubrication system components are now available in native format in the online parts library. In addition to enjoying easy CAD downloads, you can configure more complex lubrication system products and integrate them into your design process – completely free of charge. Integrate CAD data seamlessly into your layout plans without any delay.



<https://skf-lubrication.partcommunity.com>



Want your machines to perform better? Don't change oil.

What if you could get cleaner oil in your application without having to change it? With RecondOil Box from SKF, you can use the same oil over and over again. In fact, you can get cleaner oil than ever before. Your machines can perform better, and at the same time, your oil can be transformed from a costly CO₂ footprint into a sustainable asset.

Don't change oil. Change to circular use of oil.



#circularuseofoil



Automatic oil circulation lubrication systems

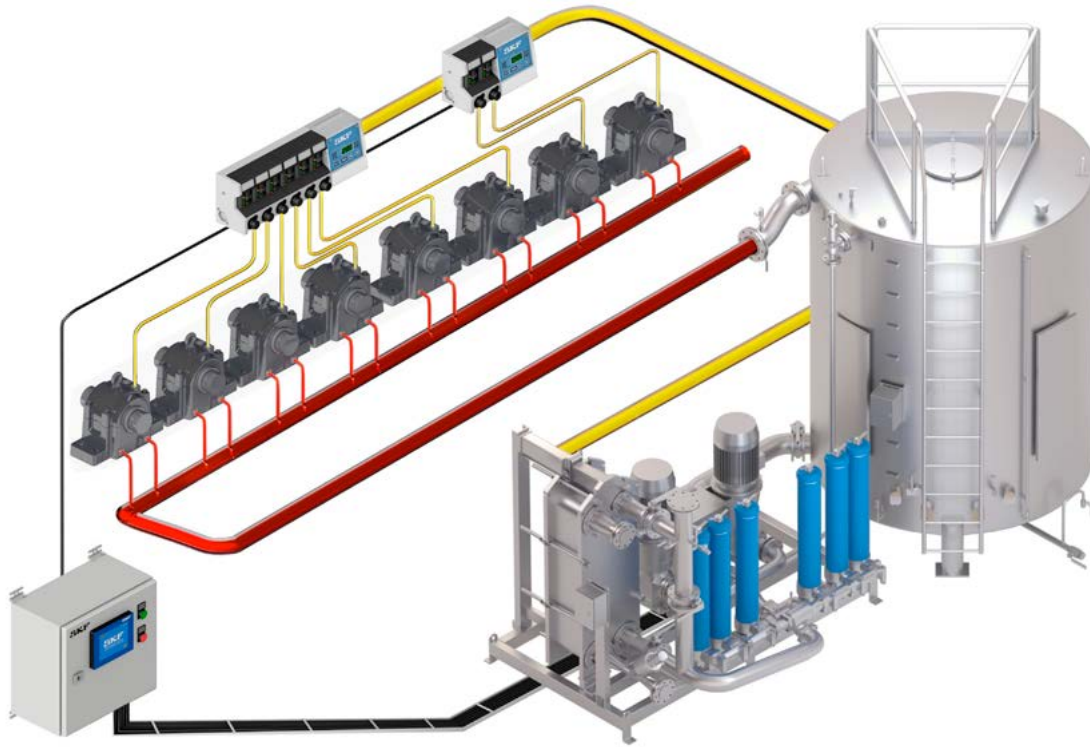

System description

SKF oil circulation systems are designed to lubricate as well as cool highly stressed bearings in nearly every size of machine. Additionally, the returning oil removes and filters out wear particles from friction points and prevents corrosion damage by removing air and water from bearings. Thus, a continuous oil flow is necessary. SKF oil circulation systems include a wide range of customized and turnkey solutions for flow rates from 0,1–3 000 l/min. They are simple to service and feature a modular design that can be expanded easily. Our patented tank design with the SKF plate separator technology increases operating efficiency to up to 90%. An oil supply system delivers the lubricant to the adjustment valves with individual settings. Flow rates can be controlled visually or electronically.

Monitoring systems with a flow rate read-out function and individual warning levels are available for a more predictive maintenance approach.

Oil circulation systems are used in pulp and paper and printing industry, as well as in many other industries. They are also used in heavy industries like marine or tunnel boring. In addition, SKF offers a range of oil circulation EEX components and systems specially designed for operations in harsh conditions and explosive atmospheres like mining or cement mills.

SKF oil circulation system consist of the following components:

- An oil supply unit with oil reservoir and pump unit/station (optionally equipped with filters and oil conditioning units)
- A control device
- One or several monitoring devices
- One or several flow metering devices
- One or several pump units
- Fittings and pipes

When planning a lubrication system, ambient conditions must be determined first. The number of lubrication points, back pressures at the lubrication points, operating temperature range, the feed pump's drive energy, control and monitoring etc. must be defined correctly. Attention also must be given to bearing or lubrication point information. SKF application engineers as well as SKF sales partners and distributors, are experts in designing lubrication systems according to these specifications. A lubrication system laid out by SKF and partners allows the supply of the correct amount of lubricant at the best time to lubricate. A properly designed lubrication system reduces wear, minimizes pollution caused by over-lubrication and helps to extend machine service life.

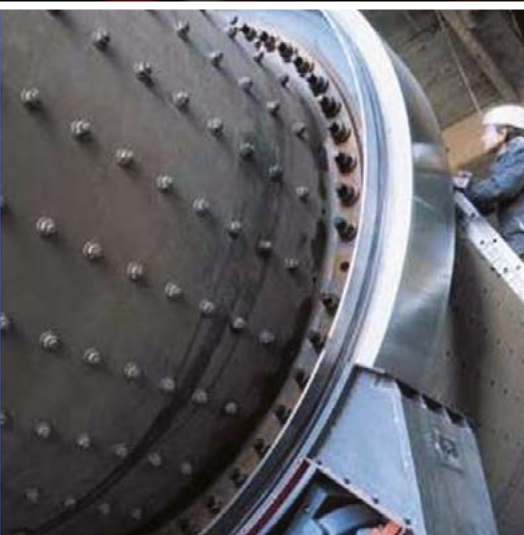
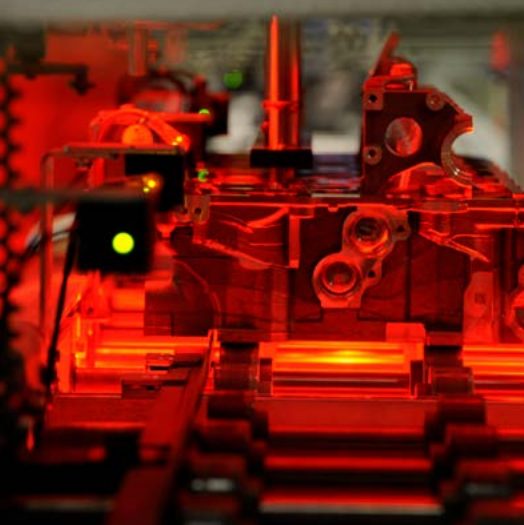

System advantages

- Cools highly stressed bearings
- Removes free water from system
- Bearing flooding protection with integrated control system
- Durable pump series designed for 24/7 operation
- Oil reservoir sizes from 3 to 40 000 liters; (0.79 to 10 567 gal)
- High operating efficiency
- Easy expansion of the lubrication system
- Able to pump long distances and within a wide temperature range

Applications

SKF CircOil lubrication systems are suitable for various industries that operate 24/7. While cooling is the predominant task of these systems, they equally supply bearings and gearboxes with clean oil at the correct temperature and viscosity. Small, highly efficient oil reservoirs provide a high level of machine availability and save money at the same time.

A large variety of flow meters allows for fit-for-purpose solutions and offers state-of-the-art monitoring and digitalization of flow information. Tailor-made controllers support stand-alone operation of SKF oil circulation lubrication systems.

- Pulp and paper industry
- Metals
- Automobile presses
- Automation
- Printing
- Food and Beverage
- ATEX
- API

Recommended product combinations

Product combination matrix

	Oil supply units					Pumps								
	MF	FLMF	SM	OCU	Flowline	Streamline	M/MF	FLM/ FLMF	ZP	ZM ¹⁾	ZM ²⁾	143 ³⁾	143 ⁴⁾	ZPU 09/ ZPU 09A
Adjustable metering valves														
Variolub	-	-	•	•	•	•	-	-	-	-	-	•	•	-
Safeflow	-	-	•	•	•	•	-	-	-	-	-	•	•	-
Flowline monitor	-	-	•	•	•	•	-	-	-	-	-	•	•	-
Flow restrictors														
VD	•	•	•	-	-	-	•	•	•	•	-	-	-	-
242	•	•	•	-	-	-	•	•	•	•	-	-	-	-
Progressive metering devices														
PSG 1	-	-	-	-	•	•	-	-	-	-	-	•	•	-
PSG 2	-	-	-	-	•	•	-	-	-	-	-	•	•	-
PSG 3	-	-	-	-	•	•	-	-	-	-	-	•	•	-
VP	-	-	-	-	-	-	-	-	-	-	-	•	•	-
Flow dividers														
SMT	-	-	-	-	-	•	-	•	•	•	-	•	•	-
Flow limiters														
SMB 3	-	-	•	-	•	•	-	-	-	-	-	•	•	-
SMB 6	-	-	•	-	•	•	-	-	-	-	-	•	•	-
SMBM-X	-	-	•	-	•	•	-	-	-	-	-	•	•	-
SMBM-V	-	-	•	-	•	•	-	-	-	-	-	•	•	-
SMB 13	-	-	•	-	•	•	-	-	-	-	-	•	•	-
SMB 14	-	-	•	-	•	•	-	-	-	-	-	•	•	-
Control units														
ST-2240-Circ	-	-	•	-	•	•	-	-	-	-	-	-	-	-
ST-RCU	-	•	•	-	-	-	-	-	-	-	-	-	-	-
ST-RCU-SUMP	-	•	•	-	-	-	-	-	-	-	-	-	-	-
Flowline Software	-	-	•	•	•	•	-	-	-	-	-	-	-	-
Monitoring devices														
WS 32/33/35	•	-	-	-	-	-	-	-	-	-	-	-	-	-
WS63-2/68	•	-	-	-	-	-	-	-	-	-	-	-	-	-
SMLS-G1	-	-	•	•	•	•	-	-	-	-	-	-	-	-
SMLS-G3/4	-	-	•	•	•	•	-	-	-	-	-	-	-	-
171-210	•	-	-	-	-	-	•	•	•	•	•	-	-	-
SFZM	•	•	-	•	•	•	•	•	•	•	-	•	•	-
SFZ	•	•	-	•	•	•	•	•	•	•	-	•	•	-
IPM	•	•	-	•	•	•	•	•	•	•	-	•	•	-
Sump units														
FL-SUMP	-	-	-	-	•	•	-	-	-	-	-	-	-	-
SM-SUMP 100	-	-	-	-	•	•	-	-	-	-	-	-	-	-
SM-SUMP 200	-	-	-	-	•	•	-	-	-	-	-	-	-	-
Accessories														
169-460-...	•	•	-	-	-	-	•	•	•	•	•	•	•	•
750-6000	-	-	-	-	•	•	-	-	-	-	-	-	-	-

1) ZM (single-circuit)
2) ZM (multi-circuit)

3) 143 without motor
4) 143 with motor

System component highlights



Streamline oil supply unit

The customized solution from SKF for circulating oil lubrication systems with flow rates up to 4 000 l/min and steel and stainless steel tank sizes up to 40 000 l → Page 22



Flowline oil supply unit

Pressure oil station for flow rates up to 1 200 l/min with innovative stainless steel tank for optimal water and air separation with a tank size reduced by 2/3 → Page 20



SM oil supply unit

Compact, small pressure oil station for flow rates up to 7 l/min, which supplies all lubrication points from one or two small machines with clean and well-tempered oil → Page 16



Flowline monitor (FL)

Adjustable flow meters for flow rates from 0,1 to 100 l/min with easy-to-use interface and remote monitoring function, also as control panel installation → Page 56



Safeflow (SF)

Adjustable oil flow meter for flow rates from 0,04 to 56 l/min with or without alarm system

→ Page 54



SKF Variolub (SMD)

Adjustable flow meters in modular design with bypass function that allow visual and electronic monitoring of flow rates from 0,05 to 40 l/min

→ Page 52

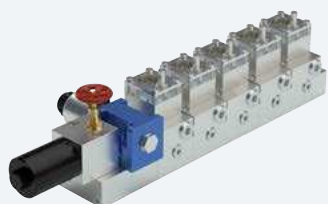

SMB(M)

Flow limiters for flow rates from 0,08 to 8 l/min, which divide the main oil flow into parallel, individual flows while compensating typical system pressure fluctuations → Page 58



PSG

Progressive distributor for flow rates of up to 6 l/min, for the cost-efficient distribution of the supplied oil flow to up to 20 individual outlets

→ Page 70



ST-2240-CIRC

Independent control for SKF oil circulation lubrication systems with a touchscreen and remote control and monitoring function → Page 80



Overview of oil circulation supply units

Compact oil supply units

Product	Lubricant mineral and synthetic oil	Flow rate ¹⁾		Ambient temperature		Reservoir size		Reservoir material	Page
		viscosity ISO VG	l/min	pts/min	°C	°F	l		
MF	5–2 000	0,12–0,5	0.23–1.06	10 to 40	50 to 104	2,7–50	5.7–105	plastic/metal	12
FLMF	20–850	1,2–2,4	2.5–5.0	10 to 40	50 to 104	2,7–50	5.7–105	metal	14
SM	30–1 000	2–7	4.2–14.8	0 to +70	+32 to 158	100	211	steel	16
OCU	15–800	5–30	10.5–63.4	-10 to 40	14 to 104	–	–	–	18

¹⁾ Valid for operating viscosity of 140 mm²/s

Large oil supply units

Product	Lubricant mineral and synthetic oil	Flow rate ¹⁾		Ambient temperature		Reservoir size		Reservoir material	Page
		viscosity ISO VG	l/min	gal/min	°C	°F	l		
Flowline	20–1 000	30–1 200	8–317	10 to 40	50 to 104	300–2 × 6 000	80–2 × 1 585	stainless steel AISI 304, 316	20
Streamline	20–1 000	30–4 000	8–1 056	10 to 40	50 to 104	1 000–40 000	264–10 566	carbon steel or stainless steel AISI 304, 316	22

¹⁾ Valid for operating viscosity of 140 mm²/s

Compact oil supply unit

MF

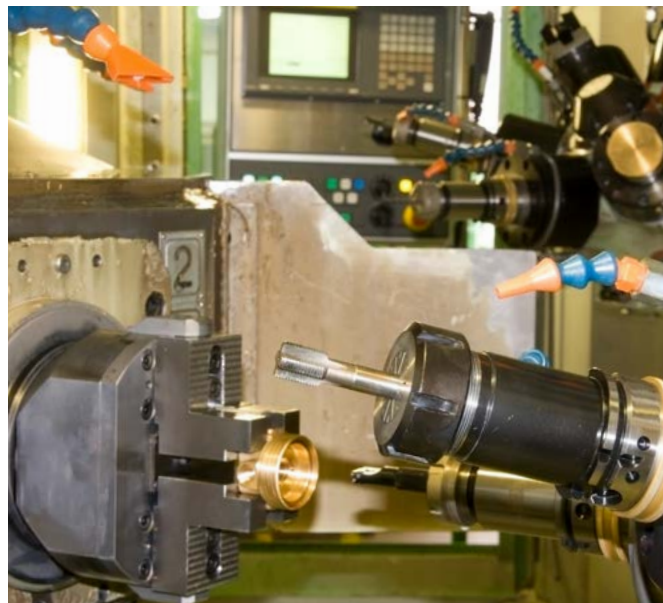

Description

MF single-circuit gear pump units are used in small oil circulation lubrication systems with pressure ranges up to 65 bar (940 psi) and high viscosities up to 2 000 mm²/s. The pump is vertically mounted on the reservoir.

MF gear pumps come with integrated pressure relief and venting valves that feed into the internal return oil connection in the adapter flange. In case of trapped air, the venting valve opens. In case of excess pressure, oil is relieved to the return oil connection via the pressure relief valve.

Features and benefits

- Designed for 24/7 operation
- Inexpensive solution
- High viscosity range
- Compact, rugged and reliable design
- Low noise level
- Integrated pressure relief valve and venting valve

Applications

- Machine tools
- Automotive
- Automation
- Textile machinery
- Metal and plastic forming machinery
- Printing

Technical data

Function	electrically operated gear pump unit; single circuit
Lubricant	environmentally friendly mineral and synthetic oils; viscosity 5–2 000 mm ² /s
Flow rate	0.12–0.5 l/min; 0.25–1.06 pts/min
Number of outlets	1
Ambient temperature	+10 to 40 °C; +50 to 104 °F
Oil temperature	+10 to 65 °C; +50 to 149 °F
Operating back pressure	max. 65 bar; max. 940 psi
Suction height	500 mm; 19.68 in
Drive speed	2 600–2 700 min ⁻¹
Motor ¹⁾	3-phase motor
Voltage	220–240/380–420 V AC at 50 Hz
Rated power	0.075–0.18 kW
Pressure connection	M 14 × 1,5 for Ø 8 mm
Seal material	NBR, FPM
Reservoir	2,7l; 6l; 15 l; 50l; 5.7pts; 12.7 pts; 31.7 pts; 105 pts
Reservoir material	plastic, metal
Protection class	IP 54
Dimensions	min. 131 × 88 × 209 mm max. 131 × 88 × 220 mm min. 5.16 × 3.54 × 8.23 in max. 5.16 × 3.54 × 8.66 in
Mounting position	horizontal ²⁾ or vertical
Approvals (dep. on model)	CE, UL, CSA

¹⁾ Further motor designs available on request.

²⁾ with special seal design

NOTE

Further technical information, technical drawings, accessories, spare parts or product function descriptions available on SKF.com/lubrication:

1-1204-2-EN, 951-170-001 EN, 951-170-002 EN

Compact oil supply unit

MF

MF pump unit with reservoir

Order number ¹⁾	Viscosity	Flow rate ²⁾		Reservoir size		material	design	level sensor	filter	gauge
		mm ² /s	l/min	pts/min	l					
MF1-BW3-S20+1GD	20–2 000	0,12	0.25	2,7	5,7	metal	wall mounting	min. fill level warning	–	–
MF1-KW3-S15+1GD	20–1 000	0,12	0.25	2,7	5,7	plastic	wall mounting	min. fill level warning	–	yes
MF2-BW7+299	20–1 000	0,20	0.42	6	12.7	metal	wall mounting	min. fill level warning	–	–
MF2-KW6-S8+299	20–2 000	0,20	0.42	6	12.7	plastic	wall mounting	–	pressure filter	–
MF5-BW7+140	20–1 000	0,50	1.0	6	12.7	metal	wall mounting	min. fill level warning	–	–
MF5-KW6+299	20–1 000	0,50	1.0	6	12.7	plastic	foot design	min. fill level warning	–	–
MF5-BW16-S223+299	20–1 000	0,50	1.0	15	31.7	metal	foot design	min. and max. fill level warning	–	–
MF5-BW51-S22+29G	20–1 000	0,50	1.0	50	105	metal	foot design	min. and max. fill level warning	pressure filter	yes

¹⁾ Recommended oil filtration for MF pumps: According to ISO 440620/17/14, NAS code (1638) class 8, SAW AS 4059 class 8

²⁾ On an operating viscosity of 140 mm²/s and 5 bar back pressure

Compact oil supply unit

FLMF



Description

The SKF FLM vane pump unit is a simple and reliable solution suitable for usage in small oil circulation systems with low pressure and low viscosity range. Because of its high suction capacity of up to 3 m (the SKF FLM pump unit is often used as a sump pump). SKF vane pumps can deliver both oil and oil/air mixtures and provide a higher suction capability than gear pump units. Two different pump designs of the pump unit are available: one allows the pump to be mounted separately from the reservoir (FLM) and the other allows the pump to be flange-mounted on the reservoir (FLMF) both vertically and horizontally. When installed on the side (horizontally), ensure that the unit is mounted above the maximum lubricant level. Special designs with a sealed flange for mounting below the lubricant level are available on request.

Features and benefits

- Simple, reliable and cost-effective solution
- Low-wear and low-maintenance
- High suction capacity (3 m)
- Designed for 24/7 operation
- Delivers oil and air mixtures
- Fail safe running functions

Applications

- General Industry
- Machine Tools
- Automotive
- Automation

Technical data

Function	electrically operated vane pump unit
Lubricant	oil, viscosity 20–850 mm ² /s
Flow rate	1,2–2,4 l/min; 2,5–5,0 pts/min
Number of outlets	1
Ambient temperature	+10 to 40 °C; +50 to 104°F
Oil temperature	+10 to 65 °C; +50 to 149 °F
Operating back pressure	max. 6 bar, max. 87 psi
Suction height ¹⁾	max. 3 000 mm; 118.1 in
Drive speed	2 700 min ⁻¹
Motor ²⁾	3-phase motor
Voltage	220–240/380–420 V AC at 50 Hz
Rated power	0,075 kW
Suction connection	M16×1,5
Pressure connection	M14×1,5
Reservoir	2,7–50 l; 5.7–105 pts
Reservoir material	plastic, metal
Protection class	IP 54
Dimensions	max. 216 × 88 × 134,5 mm max. 8.5 × 3.46 × 5.29 in
Mounting position	horizontal

¹⁾ Based on operating viscosity of 140 mm²/s at a back pressure of p = 5 bar.

²⁾ Further motor designs available on request.



NOTE

Further technical information, technical drawings, accessories, spare parts or product function descriptions available on SKF.com/lubrication:

1-1204-2-EN, 951-170-001 –EN, 951-170-002 –EN

Compact oil supply unit

FLMF

FLMF with reservoir

Order number ¹⁾	Viscosity		Flow rate ²⁾		Back pressure		Reservoir size		Suction height		design	level sensor
	mm ² /s	l/min	pts/min	bar	psi	l	pts	mm	in			
FLMF12-BW3-2+299	20–850	1,2	2.5	6	87	2,7	5.7	3 000	118	wall mounting	min. and fill level	
FLMF12-BW7+299	20–850	1,2	2.5	6	87	6	12.6	3 000	118	wall mounting	min. and fill level	
FLMF12-BW16+299	20–850	1,2	2.5	6	87	15	31.7	3 000	118	foot design	min. and fill level	
FLMF24-BW51-S2+MWZ	20–500	2,4	5.0	3	44	50	105	1 000	40	foot design	min. and max. fill level	

¹⁾ Recommended oil filtration for MF pumps: According to ISO 440620/17/14, NAS code (1638) class 8, SAW AS 4059 class 8

²⁾ On an operating viscosity of 140 mm²/s and 5 bar back pressure

Compact oil supply unit

SM



Description

Compact SM oil circulation units can be delivered with 30, 100 or 200 liter painted or Stainless Steel reservoir. These units can provide oil for one or two small machines with a total flow rate up to 20 l/min. The system pressure level is adjusted by variable speed drives (VFD) or with traditional pressure regulating valve. The reservoir is equipped with a heater to control oil viscosity at start up. An optional water or air cooler will reduce the temperature of filtered oil to desired level. The filter cartridge can be changed during operation with by-pass valve included. Systems are available with simple relay control (ST-RCU) or more advanced electronic control unit (ST-2240-CIRC).

Features and benefits

- Energy saving compact oil supply unit for one or two pumps
- Easy to use, to locate and to install
- Efficient air cooler, special application without cooler
- Compact power supply unit with frequency converters (VFD), available also without power supply
- Compact electronic control system, available also without control

Applications

- Fans, gears, refiners, washers
- Gear boxes and motors
- Presses, rolls, pumps, chippers
- Etc.

Technical data

Function	electrically operated oil supply unit
Lubricant	lubrication and hydraulic oils; 30 to 1 000 mm ² /s
Flow rate	1 to 20 l/min; 2.11 to 42.26 pts/min
Number of outlets ¹⁾	1–10
Ambient temperature	+10 to 40 °C; +50 to 104 °F
Oil temperature	+10 to 70 °C; +50 to 158 °F
Operating pressure	max. 10 bar; max. 145 psi
Reservoir	30 l, 100 l or 200 l; 8, 26 or 53 gal
Reservoir material	carbon steel (painted) or AISI 304
Thermostat controlled heater for oil tank	20 to 50 °C in 6 h; 68 to 122 °F in 6 h
Oil filtering rate	7/12/25 micron
Voltage	380–690VAC, 50/60Hz
Pressure connection	G / NPT 1/2; G / NPT 1; G / NPT 1 1/4
Protection class	IP 54
Dimensions	780 × 400 × 1 580 mm; 30.7 × 15.7 × 62.2 in; 1 200 × 550 × 840 mm; 47.2 × 21.6 × 33 in; 1 500 × 1 050 × 1 650 mm; 59 × 41.3 × 64.9 in
Mounting position	vertical

¹⁾ Number of outlets is depending on the design of the selected SKF Flowline Monitor.

NOTE

Further technical information, technical drawings, accessories, spare parts or product function descriptions available on SKF.com/lubrication:

6633EN

Compact oil supply unit

SM

SM units

Order number	Designation	Flow rate		Number of pumps	Pump position	Number of filters	Reservoir material	Cooler type	Capacity
		l/min	pts/min						
13141098	SM-30-1P-1F-PNTST-XX	1-4	1.75-7.04	1	Top	1	Steel (painted)	No cooler	-
13141099	SM-30-1P-1F-PNTST-WAC	1-4	1.75-7.04	1	Top	1	Steel (painted)	Water cooler	1,6
13141100	SM-30-1P-1F-PNTST-AIC	1-4	1.75-7.04	1	Top	1	Steel (painted)	Air cooler	1,6
13143400	SM-100-1P-1F-PNTST-XX	4-10	7.04-17.60	1	Top	1	Steel (painted)	No cooler	-
13143410	SM-100-2P-1F-PNTST-XX	4-10	7.04-17.60	2	Top	1	Steel (painted)	No cooler	-
13143450	SM-100-1P-1F-PNTST-WAC	4-10	7.04-17.60	1	Top	1	Steel (painted)	Water cooler	5,6
13143420	SM-100-1P-1F-PNTST-AIC	4-10	7.04-17.60	1	Top	1	Steel (painted)	Air cooler	5,6
13143460	SM-100-2P-1F-PNTST-WAC	4-10	7.04-17.60	2	Top	1	Steel (painted)	Water cooler	5,6
13143430	SM-100-2P-1F-PNTST-AIC	4-10	7.04-17.60	2	Top	1	Steel (painted)	Air cooler	5,6
13143467	SM-100-1P-1F-SS-XX	4-10	7.04-17.60	1	Top	1	AISI 304	No cooler	-
13143468	SM-100-1P-1F-SS-WAC	4-10	7.04-17.60	1	Top	1	AISI 304	Water cooler	5,6
13143469	SM-100-1P-1F-SS-AIC	4-10	7.04-17.60	1	Top	1	AISI 304	Air cooler	5,6
13143461	SM-100-1P-2F-SS-XX	4-10	7.04-17.60	1	Top	2 (Duplex)	AISI 304	No cooler	-
13143462	SM-100-2P-2F-SS-XX	4-10	7.04-17.60	2	Top	2 (Duplex)	AISI 304	No cooler	-
13143463	SM-100-1P-2F-SS-WAC	4-10	7.04-17.60	1	Top	2 (Duplex)	AISI 304	Water cooler	5,6
13143464	SM-100-1P-2F-SS-AIC	4-10	7.04-17.60	1	Top	2 (Duplex)	AISI 304	Air cooler	5,6
13143465	SM-100-2P-2F-SS-WAC	4-10	7.04-17.60	2	Top	2 (Duplex)	AISI 304	Water cooler	5,6
13143466	SM-100-2P-2F-SS-AIC	4-10	7.04-17.60	2	Top	2 (Duplex)	AISI 304	Air cooler	5,6
13143470	SM-200-1P-2F-SS-XX	10-20	17.60-35.19	1	Side *	2 (Duplex)	AISI 304	No cooler	-
13143471	SM-200-2P-2F-SS-XX	10-20	17.60-35.19	2	Side *	2 (Duplex)	AISI 304	No cooler	-
13143472	SM-200-1P-2F-SS-WAC	10-20	17.60-35.19	1	Side *	2 (Duplex)	AISI 304	Water cooler	11,2
13143473	SM-200-1P-2F-SS-AIC	10-20	17.60-35.19	1	Side *	2 (Duplex)	AISI 304	Air cooler	11,2
13143474	SM-200-2P-2F-SS-WAC	10-20	17.60-35.19	2	Side *	2 (Duplex)	AISI 304	Water cooler	11,2
13143475	SM-200-2P-2F-SS-AIC	10-20	17.60-35.19	2	Side *	2 (Duplex)	AISI 304	Air cooler	11,2

* Top mounted on request
1P One pump
2P Two pumps

1F Single filter
2F Double filter
WAC Water cooler

AIC Air cooler
PNTST Painted steel reservoir
SS Stainless steel reservoir

Accessories

SM unit designation	Mounting stand for controls	Terminal box for external control	Relay control incl. power supply unit	Control unit ST-2240-CIRC without power supply	Power supply unit for ST-2240-CIRC
SM-30-1P-1F-PNTST-XX	13772612	13525600	13525210	13525002	12380707
SM-30-1P-1F-PNTST-WAC	13772612	13525600	13525210	13525002	12380707
SM-30-1P-1F-PNTST-AIC	13772612	13525600	13525210	13525002	12380707
SM-100-1P-1F-PNTST-XX	13772590	13525600	13525220	13525002	12380707
SM-100-2P-1F-PNTST-XX	13772590	13525600	-	13525004	12380707
SM-100-1P-1F-PNTST-WAC	13772590	13525600	13525220	13525002	12380707
SM-100-1P-1F-PNTST-AIC	13772590	13525600	13525220	13525004	12380707
SM-100-2P-1F-PNTST-WAC	13772590	13525600	-	13525004	12380707
SM-100-2P-1F-PNTST-AIC	13772590	13525600	-	13525006	12380707
SM-100-1P-1F-SS-XX	13772590	13525600	13525220	13525002	12380707
SM-100-1P-1F-SS-WAC	13772590	13525600	13525220	13525002	12380707
SM-100-1P-1F-SS-AIC	13772590	13525600	13525220	13525004	12380707
SM-100-1P-2F-SS-XX	13772590	13525600	13525220	13525002	12380707
SM-100-2P-2F-SS-XX	13772590	13525600	-	13525004	12380707
SM-100-1P-2F-SS-WAC	13772590	13525600	13525220	13525002	12380707
SM-100-1P-2F-SS-AIC	13772590	13525600	13525220	13525004	12380707
SM-100-2P-2F-SS-WAC	13772590	13525600	-	13525004	12380707
SM-100-2P-2F-SS-AIC	13772590	13525600	-	13525006	12380707
SM-200-1P-2F-SS-XX	included	13525600	-	13525002	12380707
SM-200-2P-2F-SS-XX	included	13525600	-	13525004	12380707
SM-200-1P-2F-SS-WAC	included	13525600	-	13525002	12380707
SM-200-1P-2F-SS-AIC	included	13525600	-	13525004	12380707
SM-200-2P-2F-SS-WAC	included	13525600	-	13525004	12380707
SM-200-2P-2F-SS-AIC	included	13525600	-	13525006	12380707

Compact oil conditioning unit

OCU



Description

OCU (Oil Conditioning Unit) is an electrically operated oil cooling, filtering, and pumping unit that comes without a reservoir. Usually, the unit is installed close to machines like large gearboxes and bearing housings having an oil bath. OCU removes contamination effectively and reduces oil temperature affecting positively bearing and gear life. Three different OCU models are available, with an air cooler, with a water cooler, and without a cooler where only filtration is needed. Large oil bath volumes can be equipped with oil low-level sensors and instrumentation blocks with temperature and pressure sensors to safeguard system operation. Even small oil circulation lubrication systems can be created by adding flowmeters and control systems. For extremely high oil volumes several OCU units can be installed back to back for fail-safe redundant operation. A number of corrosion-resistant designs for outdoor and off-shore applications shall complete the range.

Features and benefits

- Low noise, high efficiency pump unit
- Reduces wear in gears and bearings by good filtration
- Improves lubrication film and extends machine life
- Increases the service life of oil up to 5 times and more
- Optional available incl. monitoring and power supply unit
- Optional available stainless steel design units
- Virtually maintenance free

Applications

- Large bearing houses, compressors
- Turbine systems, vacuum pumps
- Gearboxes

Technical data

Function principle	electrically operated oil conditioning, pumping, cooling and filtration unit
Lubricant	lubrication and hydraulic oils; 15 to 800 mm ² /s
Lubricant viscosity at start-up	2 000 mm ² /s
Operating temperature	10 to +40 °C; 14 to +104 °F
Oil temperature	10 to +80 °C; 50 to +176 °F
Operating pressure	max. 12 bar; max. 174 psi
Flow rate	5 to 30 l/min, 10.5 to 63 pts/min
Oil filtering rate	25 microns (12 and 7 on request)
Opening pressure, safety valve	adjustable 10-15 bar
Suction port connection:	
SKF-OCU 5, 10 l/min	G3/4
SKF-OCU 30 l/min	G1
Pressure port connection	G1
Water cooler inlet connection	G1
Water cooler outlet connection	G1
Cooling capacity, water cooler	0,13-0,5 kW/°C
Cooling capacity, air cooler	0,15-0,5 kW/°C
Protection class	IP 65
Motor voltage, oil pump	400/690 V, 50 Hz; 460 V, 60 Hz
Motor power, oil pump	0,55-1,1 kW
Motor voltage, air cooler	230/400 V, 50 Hz; 460/480 V, 60 Hz
Motor power, air cooler	0,37-0,75 kW
Materials:	
Housing	painted steel or stainless steel
Dimensions	max. 677 × 610 × 1 032 mm; max. 26.6 × 24.0 × 40.6 in
Mounting position	upright

NOTE

Further technical information, technical drawings, accessories, spare parts or product function descriptions available on SKF.com/lubrication:

10160/2 EN

Compact oil conditioning unit

OCU

OCU, oil conditioning units

Order number	Designation	Cooler	Flow rate ¹⁾		Cooling capacity	Pump motor ²⁾ (50 Hz)		Cooler motor ³⁾ (50 Hz)	Dimensions	Weight	
			l/min	pts/min		kW	min ⁻¹			mm	kg
Back plate and fittings made of steel											
13140907	OCU-05-P-400-XX	-	5	10,5	-	0,55	935	-	360×600×470	33	72.75
13140908	OCU-10-P-400-XX	-	10	21	-	0,75	1 450	-	360×600×470	33	72.75
13140909	OCU-30-P-400-XX	-	30	63	-	1,10	1 450	-	360×600×470	45	99.20
13140911	OCU-05-P-400-AIC	Air cooler	5	10,5	0,15	0,55	935	0,37	360×620×620	60	132.27
13140912	OCU-10-P-400-AIC	Air cooler	10	21	0,15	0,75	1 450	0,37	360×620×620	60	132.27
13140913	OCU-30-P-400-AIC	Air cooler	30	63	0,50	1,10	1 450	0,75	360×620×620	76	167.55
13140901	OCU-05-P-400-WAC	Water cooler	5	10,5	0,13	0,55	935	-	360×600×590	38	83.77
13140904	OCU-10-P-400-WAC	Water cooler	10	21	0,13	0,75	1 450	-	360×600×590	38	83.77
13140906	OCU-30-P-400-WAC	Water cooler	30	63	0,50	1,10	1 450	-	360×600×590	53	116.84
Back plate and fittings made of stainless steel											
13140925	OCU-05-P-400-WAC SS	Water cooler	5	10,5	0,13	0,55	935	-	360×600×590	38	83.77
13140926	OCU-10-P-400-WAC SS	Water cooler	10	21	0,13	0,75	1 450	-	360×600×590	38	83.77
13140928	OCU-30-P-400-WAC SS	Water cooler	30	63	0,5	1,10	1 450	-	360×600×590	53	116.84

- 1) Other flow rates and motor voltages available on request. Adjustable flowrate available with VFD.
Special units with additional high capacity filter and portable trolley available on request.
2) Oil pump motor 400/690 V, 50 Hz; 460 V, 60 Hz
3) Air cooler motor 230/400 V, 50 Hz; 460/480 V, 60 Hz

Hydraulic plan

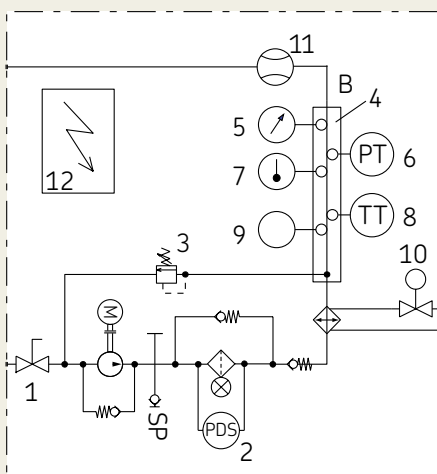

Typical combinations

- A) OCU unit with water cooler, shut-off valve, clogging indicator, measurement block, thermostatic water control valve, temperature gauge and pressure transmitter
(→ identifier 1, 2, 4, 6, 7)
B) OCU unit with air cooler, shut-off valve, clogging indicator, measurement block, temperature transmitter and pressure gauge
(→ identifier 1, 2, 4, 5, 8)
C) Above models with suitable flowmeter and pressure regulator valve
(→ identifier 11, 3)

Accessory options

Order number	Identifier	Designation
13396105	1	Shut-off valve, suction connection
13396100	1	Shut-off valve OCU-30, suction connection
13608504	2	Electrical filter clogging indicator
13602245	3	Pressure regulator for flowmeter
13396140	4	Measurement block for instruments
13396200	5	Pressure gauge
13396180	6	Pressure transmitter+display
13396240	7	Thermometer
13396220	8	Temperature transmitter+display
13396160	9	Moisture sensor
13396260	10	Thermostatic water control valve
*	11	Flow meter
*	12	Junction box, power supply, control
13149108	-	Protection cover OCU-5/10/30, painted
13149128	-	Protection cover OCU-5/10/30, AISI 304
13396320	-	Frequency converter, OCU-05/10
13396340	-	Frequency converter, OCU-30
13101039	-	Filter element for OCU units 05 & 10, (22µ)
13101038	-	Filter element for OCU units 05 & 10, (12µ)
13101037	-	Filter element for OCU units 05 & 10, (7µ)
13101044	-	Filter element for OCU unit 30, (22µ)
13101043	-	Filter element for OCU unit 30, (12µ)
13101042	-	Filter element for OCU unit 30, (7µ)

Large oil supply unit

Flowline



Description

SKF Flowline is an oil supply unit for oil circulation systems. The unique cylindrical design of the stainless-steel reservoir saves space and allows a much shorter oil rest time, which means that only half of the amount of oil is required compared to traditional reservoirs. The unit also features a perfect arrangement and interaction of pumps, filters, monitoring and smart control devices, resulting in a first-class oil circulation and oil conditioning system. An oil conditioning system that can efficiently reduce contaminants such as abrasive and oxidized particles, air and water. In addition, SKF Flowline units are equipped with reservoir heating to support smooth and a virtually leakage-free machine start-up. Our well proven standard Flowline range can be enhanced with extra fine filters, head space air dryer, oil condition sensors or control unit based on customer need and application. Other essential oil circulation system components like flowmeters, telescopic return line pipes, sump pump units will complete oil circulation lubrication offer.

Features and benefits

- Maintenance friendly
- Oil service life extension
- Up to 50% smaller reservoirs
- Water and energy use reduction
- Reduced wear and tear due to improved oil quality
- Control for automated start-up and early warnings

Applications

- Paper machines
- Continuous casters
- Rolling mills
- Industrial gearboxes
- Industrial fans

Technical data

Function	electrically operated oil supply unit incl. reservoir
Lubricant	lubrication and hydraulic oils; viscosity 20 to 1 000 mm ² /s
Ambient temperature	10 to 40 °C; 50 to 104 °F
Oil temperature	10 to 70 °C; 50 to 158 °F
Operating back pressure	max. 16 bar; 232 psi
Flow rate	30 to 1 200 l/min 8 to 317 gal/min
Number of screw pumps	2
Motor	3-phase, according to DIN IEC 60038
Rated power	1.1 to 37 kW
Reservoir sizes	300 up to 2 × 6 000 l 80 up to 2 × 1 585 gal
Material reservoir	stainless steel AISI 304 or AISI 316
Level control	transmitter
Filtration rate	7 µm
Heating capacity	1,2 to 40 kW (depending on model)
Dimensions	min. 1 600 × 1 200 × 1 500 mm min. 62.9 × 47.2 × 59.0 in max. 8 000 × 4 000 × 2 900 mm max. 314.9 × 157.4 × 114.1 in
Weight (depending on model)	350 to 7 100 kg 770 to 15652 lbs
Mounting position	upright



NOTE

Further technical information, technical drawings, accessories, spare parts or product function descriptions are available on SKF.com/lubrication:

19488 EN

Large oil supply units

Flowline



Flowline oil supply unit - variants

Designation	Design options		Flow rate max.		Dimensions		Weight (reservoir and pumping unit)	
	Basic	Extended	l/min	gal/ min	mm	in	kg	lbs
FL-300 ¹⁾	•	•	30	8	1 600×1 200×1 500	62.9×47.2×59.0	350	770
FL-500 ¹⁾	•	•	50	13	1 650×1 200×1 750	65.0×47.2×68.8	500	1 103
FL-1000 ¹⁾	•	•	100	25	2 200×1 500×1 750	86.6×59.0×68.8	1 600	3 527
FL-2000 ¹⁾	•	•	200	52	2 500×1 900×2 200	98.4×74.8×86.6	1 800	3 968
FL-3000 ¹⁾	•	•	300	79	4 000×2 000×2 900	157.4×78.7×114.1	1 830	4 034
FL-4000 ¹⁾	•	•	400	105	4 000×2 000×3 200	157.4×78.7×126.0	2 400	5 292
FL-6000 ¹⁾	•	•	600	158	5 200×2 500×3 300	204.7×98.4×129.9	3 550	7 826
FL-7000 ¹⁾	•	•	700	184	5 200×2 600×3 500	204.7×102.4×138.8	3 650	8 047
FL-9000 ¹⁾	•	•	900	238	5 500×2 500×3 800	216.5×98.4×149.6	3 950	8 708
FL-12000 ¹⁾	•	•	1 200	345	8 000×4 000×2 900	314.9×157.4×114.1	7 100	15 652

¹⁾ SKF Flowline oil supply unit basic and extended variant or ready for customization.

Basic and extended design

Flowline oil supply units are offered in two versions, basic and extended, to simplify selection process and ensure suitability for most common applications met in heavy process industries. Recommended components are carefully selected and system designs are tested for best possible compatibility and performance. However we always consider application and customer needs for best outcome.

High pressure design

Flowline oil supply units are offered with additional oil high pressure unit for journal bearings common on mineral processing ball and bar mills.

Flowline oil supply unit - standard designs

	Basic version	Extended version (example)
Reservoir material	stainless-steel (AISI 304)	stainless-steel (AISI 316)
Pump	2 standby screw pumps	2 standby screw pumps
Power backup	–	UPS
Filter	1 standby filter	double filters
Filter monitoring	switch	transmitter
Heater	sleeve element	extra elements
Cooler	single plate	double plate
Control unit	ST-2240-Circ, made of painted steel	ST-2240-Circ, made of stainless-steel (AISI 316)
Power supply	cabinet, made of painted steel	cabinet, made of stainless-steel (AISI 316)
Level control	low level alarm	real time
Draining alarm	–	•
Pressure sensor	•	•
Temperature sensor	•	•
Contamination sensor	–	•
Oil moisture sensor	–	•
Air dryer	–	•
Kidney loop solution	–	SKF SFD SKF RecondOil box (deep filtration)

Large oil supply unit

Streamline



Description

SKF Streamline oil supply units are SKF's customized solution when it comes to oil circulation lubrication systems. They come with reservoir sizes of up to 40 000 liters in both carbon steel and stainless steel and provide equally superior water and air separation properties compared with the SKF Flowline product series. These reservoirs have a rectangular shape and typically require only one-third of the tank volumes of traditional oil tanks. Advanced technology and the unique SKF tank design guarantee the highest possible oil quality and condition.

Features and benefits

- Increased machine availability due to optimal oil treatment
- Cost savings on oil purchasing, handling and disposal
- Energy savings
- Less environmental impact
- 50% reduction in reservoir size compared to traditional oil tanks
- 80% more air and water removal than traditional oil tanks
- 90% tank efficiency
- Dimensions can be adapted to machine footprint

Applications

- Pulp and paper industry
- Metals
- Mining
- Industrial gearboxes

Technical data

Function	electrically operated screw pump unit
Lubricant	hydraulic and lubricating oils; viscosity 20 to 1 000 mm ² /s
Flow rate	30 to 4 000 l/min; 8 to 1 057 gal/min
Ambient temperature	0 to +70 °C; +32 to 158 °F
Oil temperature	+10 to 70 °C; +50 to 158 °F
Operating back pressure	max. 25 bar max. 363 psi
Rated power	1.1 to 75 kW
Reservoir	1 000–40 000 l 264–10 566 gal
Material reservoir	carbon steel or stainless steel AISI 304 or AISI 316
Dimensions	depending on unit size
Mounting position	pump skid mounting on separate base frame



NOTE

For further technical information, technical drawings, accessories, spare parts or product function descriptions, please contact your local SKF sales representative.

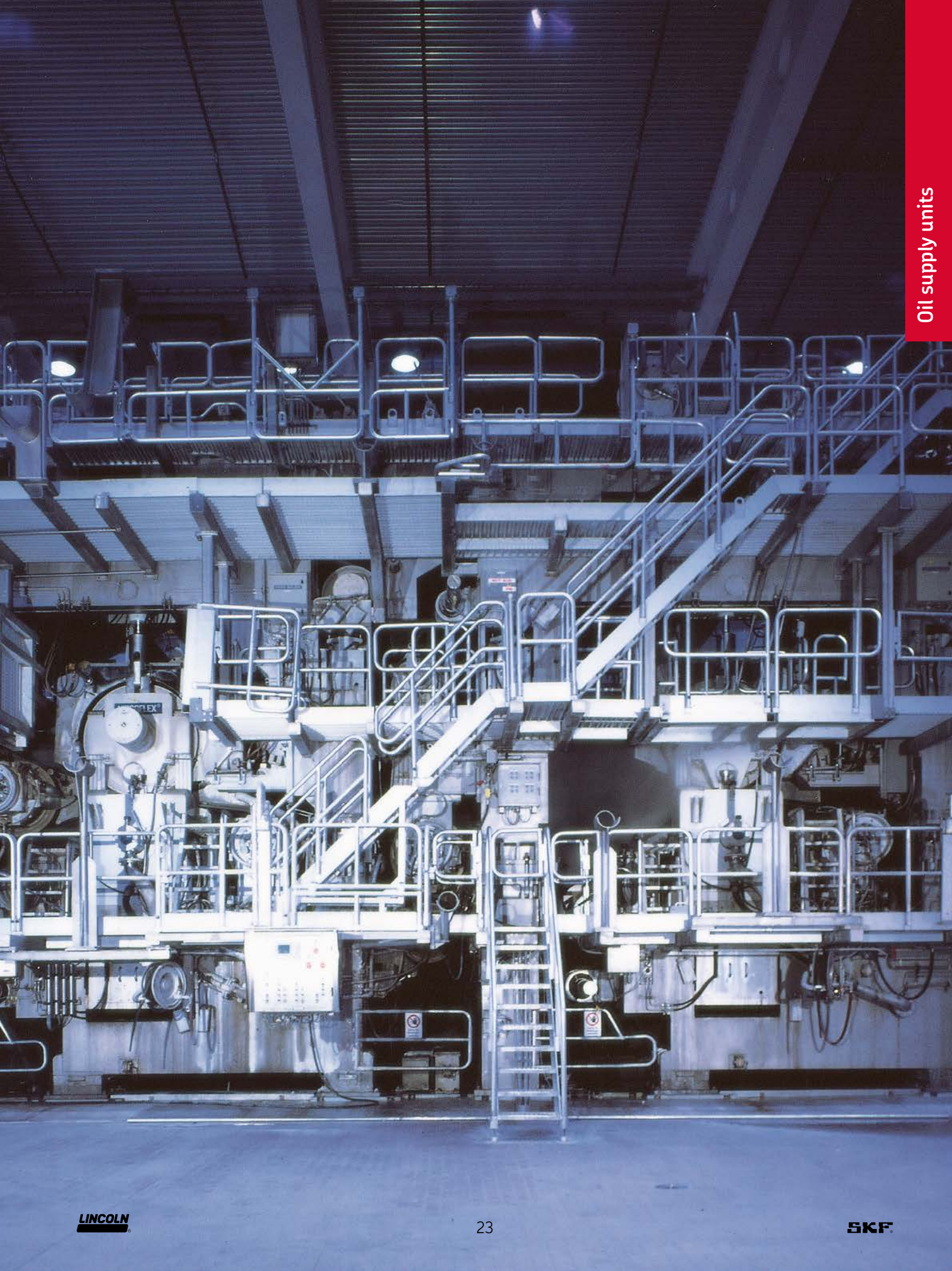



Overview of oil circulation pumps

Single-circuit oil pumps

Product	Function type	Outlets	Flow rate ¹⁾ max.		Operating back pressure max.		Suction height max.		Page
			l/min	pts/min	bar	psi	mm	inch	
M/MF	gear pump	1	0,5	1.06	65	942	500	19.7	22
FLM/FLMF	vane pump	1	2,4	5.0	6	87	3 000	118.1	28
ZP	gear pump	1	2,5	5.3	25	363	1 000	39,4	30
ZM (single-circuit)	gear pump	1	2,5	5.3	30	435	1 000	39.4	32
143	gerotor pump	1	50	105.7	50	725	1 000	39.4	36

¹⁾ Valid for operating viscosity of 140 mm²/s

Multi-circuit oil pumps

Product	Function type	Outlets	Flow rate per outlet ¹⁾ max.		Operating back pressure max.		Suction height max.		Page
			l/min	pts/min	bar	psi	mm	inch	
ZM (multi-circuit)	gear pump	5-20	0,45	0.951	20	290	500	19.7	38

¹⁾ Valid for operating viscosity of 140 mm²/s

Hydrostatic oil pumps

Product	Function type	Outlets	Flow rate ¹⁾ max.		Operating back pressure max.		Page
			l/min	pts/min	bar	psi	
ZPU 09/09A	piston pump	1-2	0,13	0.27	400	5 800	40

¹⁾ Valid for operating viscosity of 140 mm²/s

Gear pump

M/MF



Description

MF single-circuit gear pump units are used in small oil circulation lubrication systems with pressure ranges up to 65 bar (940 psi) and high viscosities up to 2 000 mm²/s. The pump is vertically mounted on the reservoir.

MF gear pumps come with integrated pressure relief and venting valves that feed into the internal return oil connection in the adapter flange. In case of trapped air, the venting valve opens. In case of excess pressure, oil is relieved to the return oil connection via the pressure relief valve.

Features and benefits

- Designed for 24/7 operation
- Inexpensive solution
- High viscosity range
- Compact, rugged and reliable design
- Low noise level
- Integrated pressure relief valve and venting valve

Applications

- Machine tools
- Automotive
- Automation
- Textile machinery
- Metal and plastic forming machinery
- Printing

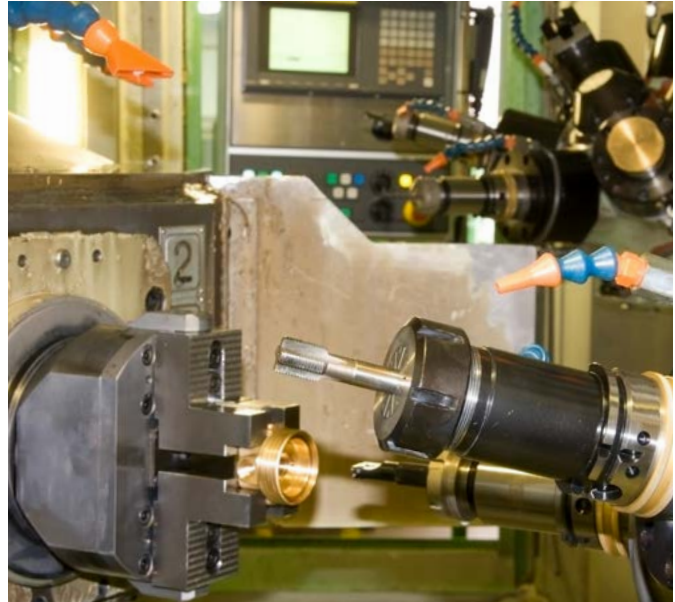

Technical data

Function	electrically operated gear pump; single circuit
Lubricant	environmentally friendly mineral and synthetic oils; viscosity 5–2 000 mm ² /s
Flow rate	0,12–0,5 l/min; 0,25–1,06 pts/min
Outlet	1
Operating temperature	+10 to 40 °C; +50 to 104 °F
Operating back pressure	max. 65 bar; max. 940 psi
Suction height	500 mm; 19.68 in
Drive speed	2 600–2 700 min ⁻¹
Motor ¹⁾	3-phase motor
Voltage	220–240/380–420 V AC at 50 Hz
Rated power	0,075–0,18 kW
Pressure connection	M 14 × 1,5 for Ø 8 mm
Suction connection	M 14 × 1,5 or M 16 × 1,5
Seal material	NBR, FPM
Protection class	IP 54
Dimensions	min. 131 × 88 × 209 mm max. 131 × 88 × 220 mm min. 5.16 × 3.54 × 8.23 in max. 5.16 × 3.54 × 8.66 in
Mounting position	horizontal ²⁾ or vertical
Approvals (dep. on model)	CE, UL, CSA

¹⁾ Further motor designs available on request.

²⁾ with special seal design



NOTE

Further technical information, technical drawings, accessories, spare parts or product function descriptions available on SKF.com/lubrication:

1-1204-2-EN, 951-170-001 EN, 951-170-002 EN

Gear pump

M/MF

M pumps for mounting separate from reservoir

Order number ¹⁾	Viscosity	Flow rate ²⁾		Operating back pressure max.		Drive speed	Rated power	Suction port thread	Weight	
		mm ² /s	l/min	pts/min	bar				psi	min ⁻¹
M1-2000+299	20–2 000	0,12	0.253	28	406	2 700	0,075	M14×1,5	3,15	6.94
M2-2004+299	20–2 000	0,2	0.423	12	174	2 700	0,075	M14×1,5	3,18	7.01
M2-2000+299	20–2 000	0,2	0.423	28	406	2 700	0,075	M14×1,5	3,16	6.96
M2-S14+299	20–1 000	0,2	0.423	65	940	2 700	0,075	M14×1,5	3,16	6.96
M2-2127+299	20–2 000	0,2	0.423	70	1 015	2 700	0,075	M14×1,5	3,16	6.96
M5-2000+299	20–1 000	0,5	1.06	28	406	2 700	0,075	M14×1,5	3,40	7.49
M5-2024+299	20–2 000	0,5	1.06	25	362	2 700	0,075	M14×1,5	3,37	7.43
M5-2013+299	5–500	0,5	1.06	16	230	2 700	0,075	M14×1,5	3,20	7.05
M5-S12+299	35–500	0,5	1.06	60	870	2 700	0,120	M14×1,5	3,40	7.49
M10-2002+299	10–500	1,0	2.12	15	217	2 700	0,075	M16×1,5	3,57	7.87

¹⁾ Recommended oil filtration for MF pumps: According to ISO 440620/17/14, NAS code (1638) class 8, SAW AS 4059 class 8

²⁾ On an operating viscosity of 140 mm²/s and 5 bar back pressure

MF pumps for flange-mounting on reservoir

Order number ¹⁾	Viscosity	Flow rate ²⁾		Operating back pressure max.		Drive speed	Rated power	Suction port thread	Weight	
		mm ² /s	l/min	pts/min	bar				psi	min ⁻¹
MF1-2000+299	20–2 000	0,12	0.253	28	406	2 700	0,075	M14×1,5	3,13	6.90
MF1-2006+299	20–2 000	0,12	0.253	6	87	2 700	0,075	M14×1,5	3,15	6.94
MF2-2000+299	20–2 000	0,2	0.423	28	406	2 700	0,075	M14×1,5	3,17	6.98
MF2-S12+299	20–1 000	0,2	0.423	65	940	2 800	0,120	M14×1,5	3,17	6.98
MF2-2127+299	140–1 000	0,2	0.423	60	870	2 700	0,075	M14×1,5	3,20	7.05
MF5-2000+299	20–1 000	0,5	1.06	28	406	2 700	0,075	M14×1,5	3,19	7.03
MF5-2014+299	5–500	0,5	1.06	12	174	2 700	0,075	M14×1,5	3,23	7.12
MF5-4012+1GD	140–1 000	0,5	1.06	60	870	2 800	0,075	M14×1,5	3,06	6.75
MF10-2001+299	20–1 000	1,0	2.11	12	174	2 700	0,075	M14×1,5	3,23	7.12
MF10-S12+1GD	20–1 000	1,0	2.11	28	406	2 800	0,120	M16×1,5	3,57	7.87
MF210-2001+299	20-150	2,0	4.22	15	217	2 700	0,075	M16×1,5	3,57	7.87

¹⁾ Recommended oil filtration for MF pumps: According to ISO 440620/17/14, NAS code (1638) class 8, SAW AS 4059 class 8

²⁾ On an operating viscosity of 140 mm²/s and 5 bar back pressure

Vane pump

FLM/FLMF



Description

The SKF FLM vane pump unit is a simple and very reliable solution suitable for usage in small oil circulation systems with low pressure and low viscosity range. Because of its high suction capacity of up to 3 m (the SKF FLM pump unit is often used as a sump pump). SKF Vane pumps can deliver both oil and oil/air mixtures and provide a higher suction capability than gear pump units. Two different pump designs of the pump unit are available, one allows the pump to be mounted separately from the reservoir (FLM) or the other allows the pump to be flange-mounted on the reservoir (FLMF) both vertically and horizontally. When installed on the side (horizontally), ensure that the unit is mounted above the maximum lubricant level. Special designs with a sealed flange for mounting below the lubricant level are available on request.

Features and benefits

- Simple, reliable and cost-efficient solution
- Low-wear and low-maintenance
- High suction capacity (3 m)
- Designed for 24/7 operation
- Delivers oil and air mixtures
- Fail safe running functions

Applications

- General industry
- Machine tools
- Automotive
- Automation

Technical data

Function	electrically operated vane pump
Lubricant	mineral and synthetic oils; viscosity 20–850 mm ² /s
Flow rate	1,2–2,4 l/min; 2,5–5,0 pts/min
Operating temperature	+10 to 40 °C; +50 to 104 °F
Operating back pressure	max. 3–6,6 bar; 44–87 psi
Suction height ¹⁾	1 000–3 000 mm; 39,4–118,1 in
E-motor drive	3 phase motor
Drive speed	2 700 min ⁻¹
Motor ²⁾	3-phase motor
Voltage	220–240/380–420 V AC at 50 Hz
Rated output	0,075 kW
Suction connection	M16×1,5
Pressure connection	M14×1,5
Protection class	IP 54
Dimensions	max. 216 × 88 × 134,5 mm max. 8,5 × 3,46 × 5,29 in
Mounting position	separate or flanged to reservoir
Options	with shaft butt, with slotted coupling, left or right rotating pumps

¹⁾ Based on operating viscosity of 140 mm²/s at a back pressure of p = 5 bar.

²⁾ Further motor designs available on request.



NOTE

Further technical information, technical drawings, accessories, spare parts or product function descriptions available on SKF.com/lubrication:

1-1204-2-EN, 951-170-001 –EN, 951-170-002 –EN

Vane pump

FLM/FLMF

FLM / FLMF without reservoir

Order number		Flow rate ¹⁾		Suction height		Operating back pressure max.		Viscosity
flange-mounting	separate mounting	l/min	pts/min	mm	inch	bar	psi	mm ² /s
FLMF12-2000+299	FLM12-2000+299	1,2	2.5	3 000	118.1	6,6	95	2–850
FLMF24-2000+299	FLM24-2000+299	2,4	5.0	3 000	118.1	3	44	2–500

¹⁾ Recommended oil filtration for FLM/FLMF pumps: According to ISO 4406 20/17/14, NAS code (1638) class 8, SAWAS 4059 class 8
²⁾ On an operating viscosity of 140 mm²/s and 5 bar back pressure

Gear pump

ZP



Description

ZP gear pumps are manufactured for clockwise (ZP12-2; ZP1) or counterclockwise (ZP1-S1) rotation, with constant direction of delivery. The indicated delivery rates apply to an operating viscosity of 140 mm²/s and a back pressure of 5 bars (72 psi). They allow direct drive. ZP operated by electrical motors are ZM pumps.

Features and benefits

- Designed for 24/7 operation
- Wide viscosity range
- Compact, rugged and reliable design
- Low noise level
- Integrated pressure relief valve and venting valve

Applications

- Machine tools
- General industry
- Printing
- Metal forming

Technical data

Function	gear pump
Lubricant	mineral and synthetic oils; viscosity 20–1 000 mm ² /s
Flow rate:	
ZP12-2	1,2 l/min; 2,5 pts/l/min
ZP1; ZP1-S1	2,5 l/min; 5,3 pts/min
Operating temperature	+10 to +80 °C; +50 to 175 °F
Operating back pressure:	
ZP12-2	max. 25 bar; max. 363 psi
ZP1; ZP1-S1	max. 20 bar; max. 290 psi
Suction height: ¹⁾	
ZP12-2	500 mm; 19,7 in
ZP1; ZP1-S1	1 000 mm; 39,4 in
Drive direction: ²⁾	
ZP12-2; ZP1	clockwise
ZP1-S1	counterclockwise
Connection suction	G1/4
Pressure connection	G1/4
Dimensions	min. 60 × 60 × 85 mm max. 70 × 70 × 82 mm min. 2.36 × 2.36 × 3.35 in max. 2.76 × 2.76 × 3.23 in with shaft butt, with slotted coupling, clockwise or counterclockwise rotating pumps
Designs	

¹⁾ At 1 400 min⁻¹

²⁾ Viewing on drive shaft



NOTE

Further technical information, technical drawings, accessories, spare parts or product function descriptions available on SKF.com/lubrication:

1-1200-EN

Gear pump

ZP

ZP

Order number	Flow rate ¹⁾ at 1 400 min ⁻¹		Back pressure max.		Suction head ¹⁾		Direction of rotation ²⁾
	l/min	pts/min	bar	psi	mm	in	
ZP12-2 ³⁾	1,2	2.5	25	363	500	19.7	right
ZP1 ³⁾	2,5	5.3	20	290	1 000	39.4	right
ZP1-S1 ³⁾	2,5	5.3	20	290	1 000	39.4	left

¹⁾ with open main line at 1 400 min⁻¹ and oil viscosity of 140 mm²/min

²⁾ viewing on the drive shaft

³⁾ order adapter with ports tapped for solderless tube connection separately

Gear pump

ZM (single-circuit)



Description

ZM single-circuit gear pump units are used in small oil circulation lubrication systems with pressure ranges up to 30 bar (435 psi) and high viscosities up to 2 000 mm²/s. They consist of a gear pump, a flange, a coupling and an electric motor. The pump design suits mounting separately from the reservoir or vertically on top of the reservoir. Horizontal flange mounting below lubricant level is not allowed. ZM gear pump units come without integrated pressure relief and venting valves.

Features and benefits

- High viscosity range
- Low noise operation
- High operating back pressure
- Easy system planning

Applications

- Machine tools
- Metal and plastic forming machinery
- General industry

Technical data

Function	electrically operated gear pump
Lubricant	mineral and synthetic oils; viscosity: 20–2 000 mm ² /s
Flow rate	
ZM12:	1,2 l/min; 2,5 pts/min
ZM25:	2,5 l/min; 5,3 pts/min
Outlets	1
Operating temperature	+10 to 40 °C; +50 to 104 °F
Operating back pressure:	
ZM12	max. 30 bar; max. 435 psi
ZM25	max. 20 bar; max. 290 psi
Suction height:	
ZM12	500 mm; 19.7 in
ZM25	1 000 mm; 39.4 in
Drive speed	1 350 min ⁻¹
Motor ¹⁾	3-phase motor
Voltage	220–240/380–420 V AC at 50 Hz
Rated power	0,18 kW
Pressure connection	G 1/4; M14×1,5
Suction connection	G 1/4; M16×1,5
Protection class	IP 54
Dimensions:	
ZM12	299 × 164 × 125 mm; 11.77 × 6.45 × 4.92 in
ZM25	283 × 123 × 162 mm; 11.14 × 4.84 × 6.37 in
Mounting position	horizontal or vertical

¹⁾ Further motor designs available on request.



NOTE

Further technical information, technical drawings, accessories, spare parts or product function descriptions available on SKF.com/lubrication:

1-1204-2-EN; 951-170-002 EN

Gear pump

ZM (single-circuit)

ZM single-circuit¹⁾

Order number	Design	Motor approval	Mounting position	Flow rate ²⁾		Operating back pressure max.	
				<i>l/min</i>	<i>pts/min</i>	<i>bar</i>	<i>psi</i>
ZM12-21+1GD	foot design	CE	horizontal, separate	1,2	2.5	30	435
ZM12-31+1GD	flange design	CE	vertical, flanged	1,2	2.5	30	435
ZM12-21-S11+1GD	foot design	UL/CSA	horizontal, separate	1,2	2.5	30	435

¹⁾ Recommended filtration for ZM single-circuit pumps according to: ISO 4406 20/17/14; NAS code (1638); class 8 SAW AS 4059 class 8

²⁾ On an operating viscosity of 140 mm²/s and 5 bar back pressure

Gerotor pump

143 without motor



Description

Gerotor pump series 143 are self-priming positive-displacement pumps with fixed displacement and high efficiency. They are suitable for a variety of applications, such as hydraulic, hydrostatic, cooling as well as circulating-oil and total-loss lubrication systems. SKF gerotor pump units of product series 143 are highly efficient and operate in a flow range between 0,85 to 50 l/min at pressure up to 50 bar. They are characterized by very smooth running, low noise generation and good suction capability.

Features and benefits

- Flexible pump delivery range
- Wide viscosity range
- Smooth running
- Low-noise operation
- Good suction characteristics
- Simplified ordering

Applications

- Marine and offshore industry
- Pulp and paper and printing industries
- Commercial vehicles
- Heavy industry



Technical data

Function	gerotor pump
Lubricant	lubrication and hydraulic oils; viscosity 20 to 1 000 mm ² /s
Flow rate	0,85–50 l/min; 1.8–105.7 pts/min
Operating temperature	0 to +40 °C; +32 to 104 °F
Operating back pressure	max. 50 bar; max. 725 psi
Outlet	1
Suction height	max. 1 000 mm; 39.4 in
Drive speed	1 400–2 800 min ⁻¹
Connecting thread pressure	G 1/4 to G 1 BSPP
Connecting thread suction	G 1/4 to G 1 1/4 BSPP
Material	hydraulic cast, steel, sintered material, low-deformation case-hardened steels, NBR or FPM
Dimensions	depending on the model: min. 289 × 184 × 126 mm max. 656 × 264 × 280 mm min. 11.37 × 7.3 × 4.96 in max. 25.82 × 10.4 × 11 in
Mounting position	horizontal or vertical; foot or flange mounting.

NOTE

Further technical information, technical drawings, accessories, spare parts or product function descriptions available on SKF.com/lubrication:
1-1204-3-EN, 951-170-222-EN



3D

skf-lubrication.partcommunity.com/3d-cad-models

Gerotor pump

143 without motor

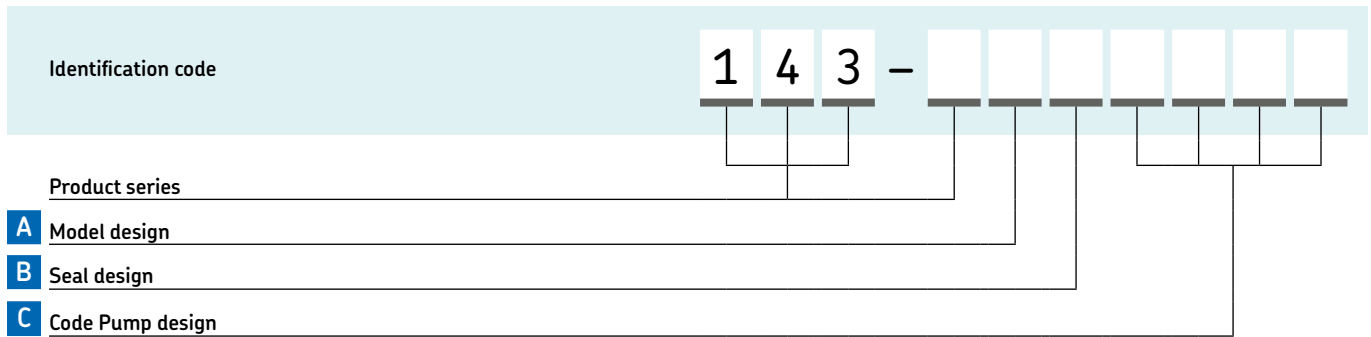

Model design

- A** 3 gerotor pump+pump flange+ shaft coupling
- 4 gerotor pump only

Seal design

- B** N NBR
- F FKM

Pump design

Code	Flow rate ¹⁾		Operating back pressure max.		Code	Flow rate ¹⁾		Operating back pressure max.	
	l/min	pts/min	bar	psi		l/min	pts/min	bar	psi
D03	1.7	3.6	30	435	M05	12,5	26.4	50	725
F02	2.5	5.3	20	290	P02	19	40.1	20	290
F05	2.5	5.3	50	725	R02	30	63.4	20	290
H02	5.25	11.1	20	290	R03	30	63.4	30	435
H05	5.25	11.1	50	725	T02	40	84.5	20	290
K02	9	19	20	290	T03	40	84.5	30	435
K05	9	19	50	725	V02	50	105.7	20	290
M02	12.5	26.4	20	290	V03	50	105.7	30	435

¹⁾ Valid for operating viscosity of 140 mm²/s

Accessories

Pressure relief valves

Order number	Flow rate	
	l/min	pts/min
WVN200-10	1,7; 2,5; 5,25	3,6; 5,3; 11,1
161-218-000	9; 12,5	19; 26,4
161-228-051	19; 30; 40; 50	40,2; 63,4; 84,5; 105,7

Gerotor pump

143 with motor



Description

Gerotor pump series 143 are self-priming positive-displacement pumps with fixed displacement and high efficiency. They are suitable for a variety of tasks and applications, such as circulating-oil and total-loss lubrication systems. SKF gerotor pumps operate in a flow range between 0,85 to 50 l/min at pressure up to 50 bar. They are characterized by very smooth running, low noise generation and good suction capability.

Features and benefits

- Flexible pump delivery range
- Wide viscosity range
- Smooth running
- Low-noise operation
- Good suction characteristics
- Simplified ordering

Applications

- Marine and offshore industry
- Pulp and paper and printing industries
- Heavy industry

Technical data

Function	electrically operated gerotor pump
Lubricant	lubrication and hydraulic oils; viscosity 20 to 1 000 mm ² /s
Flow rate	0,85–50 l/min; 1,8–105 pts/min
Operating temperature	0 to +40 °C; +32 to 104 °F
Operating back pressure	max. 50 bar; max. 725 psi
Outlet	1
Suction height	max. 1 000 mm; 39,4 in
Operating voltage	3-phase, acc. to DIN IEC 60038
Drive speed	1 400–2 800 min ⁻¹
Connecting thread pressure	G 1/4 to G 1 BSPP
Connecting thread suction	G 1/4 to G 1 1/4 BSPP
Rated power	0,18 to 5,5 kW
Protection class	IP 54 (motor)
Material	hydraulic cast, steel, sintered material, low-deformation case-hardened steels, NBR or FPM
Dimensions	depending on the model: min. 289 × 184 × 126 mm max. 656 × 264 × 280 mm min. 11,37 × 7,3 × 4,96 in max. 25,82 × 10,4 × 11 in
Mounting position	horizontal or vertical; foot or flange mounting



NOTE

Further technical information, technical drawings, accessories, spare parts or product function descriptions available on SKF.com/lubrication:

1-1204-3-EN



3D

skf-lubrication.partcommunity.com/3d-cad-models

Gerotor pump

143 with motor

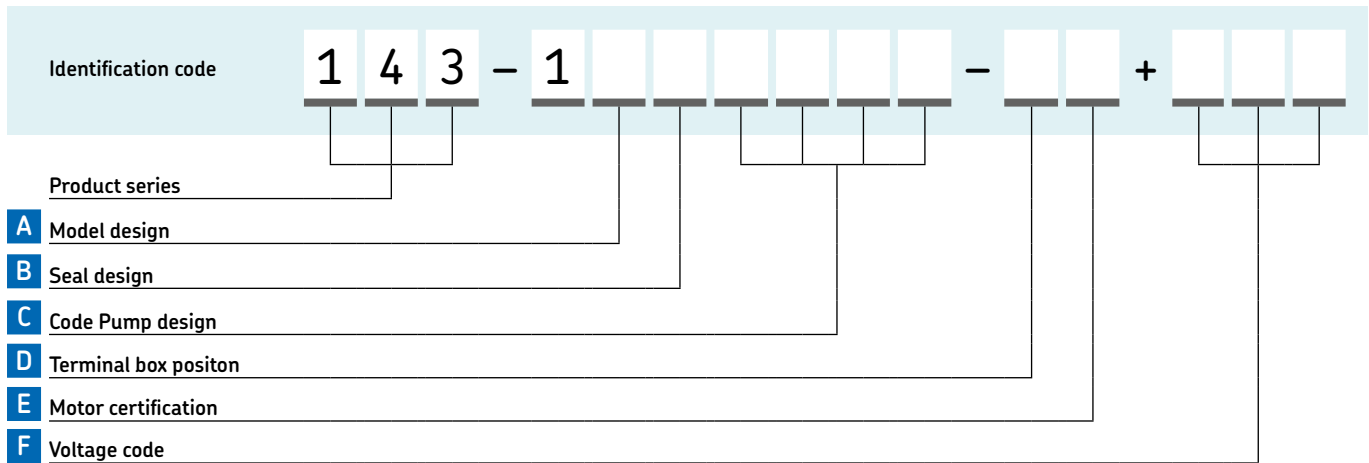

Model design

- A** 1 Motor foot (IBM34)
- 2 Motor flange (IBM14)
- 3 Gerotor pump+pump flange+ shaft coupling (without motor)
- 4 only gerotor pump (without motor)

Seal design

- B** N NBR
- F FKM

Terminal box position

as seen from shaft extension of drive side (not applicable on design without motor)

- D** R right, (standard, not on motor 1.1; 1.5 and 4 kW)
- O top (standard, on motor 1.1; 1.5 and 4 kW)
- X on motor flange design (IMB14), terminal box position on suction port side of pump

(others available on request)

Motor certification

- E** A CE (Europe)
 - B UL/CSA (USA/Canada)
- (others available on request)

Pump design

C Code	Metering quantity ¹⁾	Operating pressure	Motor drive	Operating viscosity	Size	Poles
	l/min	max. bar	kW	mm ² /s		
B03C	0,85	30	0,18	20–1 000	63	4
D03E	1,7	30	0,37	20–1 000	71	2
F02D	2,5	20	0,25	20–1 000	71	4
F05F	2,5	20	0,55	20–1 000	80	4
H02F	5,25	20	0,55	20–1 000	80	4
H05J	5,25	50	1,1	20–1 000	90	4
K02H	9	20	0,75	20–1 000	80	4
K05J	9	50	1,1	20–1 000	90	4
M02H	12,5	20	0,75	20–1 000	80	4
M05K	12,5	50	1,5	20–1 000	90	4
P02K	19	20	1,5	20–1 000	90	4
R02M	30	20	3	20–1 000	100	2
R03M	30	30	3	20–750	100	2
R03N	30	30	4	20–1 000	112	2
T02M	40	20	3	20–750	100	2
T03N	40	30	4	20–1 000	112	2
V02N	50	20	4	20–1 000	112	2
V03N	50	30	4	20–750	112	2
V03P	50	30	5,5	20–1 000	132	2

¹⁾ Nominal flow rate at motor speed 1 400/2 800 min⁻¹ according to number of motor pins.

Voltage Code V AC

- F** +1GP 220/380¹⁾; 255/440^{2) 3)}
- +1GD 230/400¹⁾; 265/460^{2) 3)}
- +1GQ 240/415¹⁾; 280/480^{2) 3)}
- +1HQ 290/500¹⁾; 330/575^{2) 3)}
- +1GH 380/660¹⁾; 440^{2) 3)}
- +1GK 400/690¹⁾; 460^{2) 3)}
- +1GL 415/720¹⁾; 480^{2) 3)}
- +1KG 400¹⁾; 460^{2) 3)}
- +1KS 240/415²⁾
- +1LL 500/575^{1) 2)}
- +1GF 200/345^{1) 3)}
- +1GG 200/345^{2) 3)}
- +MDP 220/380^{2) 3)}
- +MFN 255/440¹⁾
- +1GR 230/400^{2) 3)}
- +MMP 305/525^{1) 3)}
- +1GD 220–240/380–420^{1) 4)}
- 254–240/440–480^{2) 4)}
- 220–240/380–420^{1) 4)}
- 254–280/440–480^{2) 4)}

¹⁾ 50 Hz
²⁾ 60 Hz
³⁾ ±10 %
⁴⁾ ±5 %

Gear pump

ZM (multi-circuit)



Description

ZM multi-circuit gear pump units are self-priming and valveless pumps. They are used in oil circulation lubrication systems with 5 to 20 separate delivery circuits. Unused outlets must be returned to the reservoir. The pumps consists of an electric motor, adapter flange, coupling and a gear pump. The pump can be mounted separately from the reservoir or as a flanged pump on the reservoir. A special design with seals for horizontal mounting below lubricant level is available. The fluids to be pumped must have enough lubricity for the pump to lubricate itself.

Some of these distribution pumps require an attached, single-circuit priming pump that operates separately. The priming pump restricts differential pressure within the multicircuit pumps and helps to provide uniform delivery rates. It is advisable to filter the oil upstream of the distribution pump inlet.

Features and benefits

- High viscosity range
- Flexible due to up to 20 circuits per pump
- Suitable for hydrostatic operation
- Easy system planning
- Space-saving pump design

Applications

- Machine tools
- Metal and plastic forming machinery
- General industry

Technical data

Function	electrically operated, self-priming gear pump
Lubricant	mineral and synthetic oils; viscosity depending on model: 20–2 000 mm ² /s
Flow rate	depending on model: min. 0,015 l/min; 0.032 pts/min max. 0,45 l/min; 0.951 pts/min
Outlets	5–20
Operating temperature	+10 to 40 °C; +50 to 104 °F
Operating back pressure	max. 20 bar; max. 290 psi
Suction height	500 mm; max. 19.7 in
Drive speed	670 to 1 400 min ⁻¹
Motor	3-phase motor
Voltage	220–240/380–420 V AC at 50 Hz
Rated power	0,18–0,37 kW
Pressure connection	G 1/8 or M10×1
Suction connection	G 1/2 or M14×1,5
ZM50 ... :	M14×1,5 for Ø12 mm
ZM10 ... :	G 1/2
Material sealing	NBR, FPM
Protection class	IP 54
Dimensions	min. 325 × 152 × 125 mm max. 460 × 208 × 160,5 mm min. 12.79 × 5.98 × 4.92 in max. 18.11 × 8.18 × 6.32 in
Mounting position	horizontal, or flanged to reservoir ¹⁾

¹⁾ Only flange design version with separate seal



NOTE

Further technical information, technical drawings, accessories, spare parts or product function descriptions available on SKF.com/lubrication:

1-1204-2-EN, 951-170-002 EN

Gear pump

ZM (multi-circuit)

ZM multi-circuit pump, self-priming ¹⁾

Order number	Circuits ⁴⁾ (Outlets)	Flow rate ⁶⁾ V _a		V _b		Back pressure		Drive speed min ⁻¹	Operating viscosity mm ² /s
		l/min	pts/min	l/min	pts/min	bar	psi		
ZM502+1GD	²⁾ 5	5 × 0,2	5 × 0.423	-	-	20	290	670	20–2 000
ZM502-3+1GD	³⁾ 5	5 × 0,2	5 × 0.423	-	-	20	290	670	20–2 000
ZM505+1GD	²⁾ 5	5 × 0,45	5 × 0.951	-	-	10	145	670	20–500
ZM505-3+1GD	³⁾ 5	5 × 0,45	5 × 0.951	-	-	10	145	670	20–500
ZM1002+1GD	²⁾ 10	5 × 0,2	5 × 0.423	5 × 0,2	5 × 0.423	20	290	690	20–1 000
ZM1005+1GD	²⁾ 10	5 × 0,45	5 × 0.951	5 × 0,45	5 × 0.951	10	145	690	20–250

ZM multi-circuit pump for operation with a separate priming pump ¹⁾

Order number	Circuits ⁴⁾ (Outlets)	Flow rate ⁶⁾ V _a		V _b		Pump inlet P ₁ ⁵⁾		Drive speed min ⁻¹	Operating viscosity mm ² /s
		l/min	pts/min	l/min	pts/min	bar	psi		
ZM502-S2+1GD	²⁾ 5	5 × 0,2	5 × 0.423	-	-	30	435	690	20–500
ZM505-S2+1GD	²⁾ 5	5 × 0,45	5 × 0.951	-	-	30	435	690	20–500
ZM1002-S2+1GD	²⁾ 10	5 × 0,2	5 × 0.423	5 × 0,2	5 × 0.423	30	435	690	20–500
ZM1005-S2+1GD	²⁾ 10	5 × 0,45	5 × 0.951	5 × 0,45	5 × 0.951	30	435	690	20–500
ZM2101-2+1GD	²⁾ 20	20 × 0,015	20 × 0.032	-	-	30	435	1 400	20–1 000
ZM2102-2+1GD	²⁾ 20	20 × 0,03	20 × 0.063	-	-	30	435	1 400	20–1 000
ZM2103-2+1GD	²⁾ 20	20 × 0,05	20 × 0.105	-	-	30	435	1 400	20–1 000
ZM2104-2+1GD	²⁾ 20	20 × 0,1	20 × 0.211	-	-	30	435	1 400	20–1 000

ZM pump with built-in priming pump and adjustable pressure restriction valve ¹⁾

Order number	Circuits ⁴⁾ (Outlets)	Flow rate ⁶⁾		Pump inlet P ₁		Pump inlet P ₂		Drive speed min ⁻¹
		l/min	pts/min	bar	psi	bar	psi	
ZM1035+1GD	²⁾ 10	10 × 0,45	10 × 0.951	16	232	20	290	1 400
ZM2201+1GD	²⁾ 20	20 × 0,025	20 × 0.052	18	260	20	290	680
ZM2202+1GD	²⁾ 20	20 × 0,035	20 × 0.074	18	260	20	290	915
ZM2103+1GD	²⁾ 20	20 × 0,05	20 × 0.105	18	260	20	290	1 360

¹⁾ Recommended filtration between multicircuit pump and priming pump. According to: ISO 4406 20/17/14, NAS code (1638) class 8, SAW AS 4059 class 8

²⁾ Foot-mounted pumps for separate mounting from reservoir

³⁾ Flange-mounted pumps with special seal design

⁴⁾ Non used pump delivery ports must be returned to the oil reservoir and must **not** be blanked off

⁵⁾ P2 outlet pressure corresponds P1 ± 5 bar; 72,5 psi

⁶⁾ Valid for an operation viscosity of 140 mm²/min and a drive speed of 1 400 min⁻¹

Piston pump

ZPU 09/09A



Description

The ZPU 09/09A high-pressure pumps are designed for use in hydrostatic and hydrodynamic (start-up phase) lubrication systems. They also may be used in oil supply systems, blocking oil systems and regulation and control oil systems. The pump is suitable for oils with viscosity of 20 to 460 mm²/s. The pump shows a housing, of 8 l (16.9 pts) capacity, with a pump element and a flange with outlets and return lines, all connected to a 3-phase, multi-range or 500 V motor. The pump can be delivered with one or two outlets.

Features and benefits

- Reliable
- With one or two outlets
- Simple to service
- Built-in check-valve for ZPU 09
- Return line from pressure relief valve
- Housing integrated oil level indicator

Applications

- Turbines
- Steel mills
- Gears
- Paper machines
- Power stations

Technical data

Function	electrically operated piston pump
Operating temperature	-20 to +80 °C; -4 to +176 °F
Operating back pressure	max. 400 bar; max. 5 800 psi
Lubricant	mineral and synthetic oils; viscosity 20–460 mm ² /s
Number of outlets	
ZPU09	1
ZPU09A	2
Flow rate	
ZPU09	0,13 l/min, 0,27 pts/min
ZPU09A	2 × 0,06 l/min, 2 × 0,13 pts/min
Voltage	380–415, 420–480 V AC / 50 Hz, ±5% to ±10% 500 V AC / 50 Hz, ±10%
Outlet connection filling line	G 3/8 BSPP
Direction of rotation drive	optional
Protection class	IP 54
Dimensions	650 × 410 × 465 mm 25.59 × 16.14 × 16.31 in
Mounting position	vertical

Piston pump

ZPU 09/09A

ZPU 09/09A

Order number	Designation	Number of outlets	Flow rate per outlet		Motor
			l/min	pts/min	
605-27545-1	ZPU 09 / 08 GT-380-415, 420-480	1	0,13	0.27	3-phase gear motor, 380-415 / 420-480 V AC
605-27546-1	ZPU09 / 08GT-500	1	0,13	0.27	3-phase gear motor, 500 V AC
605-27547-1	ZPU09A / 08GT-380-415,420-480	2	0,6	0.13	3-phase gear motor, 380-415 / 420-480 V AC
605-27548-1	ZPU09A / 08GT-500	2	0,6	0.13	3-phase gear motor, 500 V AC
605-28166-1	ZPU09 / 08GT-000	1	0,13	0.27	without motor



Overview of oil circulation metering devices

Flow restrictor

Product	Lubricant viscosity	Flow rate		Outlets	Operating pressure max.		Operating temperature		Page
		mm ² /s	l/min		pts/min	bar	psi	°C	
VD	10–1 000	0,001–0,23	0.002–0.49	1	max. 10	max. 145	0 to 60	32 to 140	46

Flow divider

Product	Lubricant viscosity	Flow rate		Outlets	Operating pressure max.		Operating temperature		Page
		mm ² /s	l/min		pts/min	bar	psi	°C	
SMT	50–1 300	0,5–6,0	1.1–12.7	2	100	1 450	0 to +100	32 to 212	48

Adjustable metering valve with visual flow indication

Product	Lubricant viscosity	Flow rate		Outlets	Operating pressure max.		Operating temperature		Page
		mm ² /s	l/min;		pts/min	bar	psi	°C	
242 type A	10–1 000	0–0,01	0–0.02	1, 2, 5, 14	10	145	0 to 60	32 to 140	50
242 type B	10–1 000	0,01–1,0	0.02–2.1	2–6, 10, 12	10	145	0 to 60	32 to 140	50
242 type C	10–1 000	0,01–2,0	0.02–4.2	2–6	10	145	0 to 60	32 to 140	50

Adjustable metering valve with flow meter

Product	Lubricant viscosity	Flow rate		Outlets	Operating pressure max.		Operating temperature		Page
		mm ² /s	l/min		pts/min	bar	psi	°C	
SMD 2 (SKF VarioLub)	50–650	0,1–8,0	0.2–16.9	2	16	230	0 to 70	32 to 158	52
SMD 3 (SKF VarioLub)	50–650	4,0–40	8.5–85	1	16	230	0 to 70	32 to 158	52
SF05A (SKF SafeFlow)	1) ¹⁾ 30–1 000	0,04–0,7 ¹⁾	0.08–1.5 ¹⁾	1, 2, 4, 6, 8, 10	16	215	max. 70	max. 158	54
SF10A (SKF SafeFlow)	1) ¹⁾ 30–1 000	0,1–3,0 ¹⁾	0.2–6.3 ¹⁾	1, 2, 4, 6, 8, 10	16	215	max. 70	max. 158	54
SF15A (SKF SafeFlow)	1) ¹⁾ 30–1 000	0,2–7,2 ¹⁾	0.4–15.2 ¹⁾	1, 2, 4, 6, 8, 10	16	215	max. 70	max. 158	54
SF20A (SKF SafeFlow)	1) ¹⁾ 30–1 000	0,6–17 ¹⁾	1.3–35.9 ¹⁾	1, 2, 4, 6	16	215	max. 70	max. 158	54
SF30A (SKF SafeFlow)	1) ¹⁾ 30–1 000	2,5–56 ¹⁾	5.3–118.3 ¹⁾	1	16	215	max. 70	max. 158	54
FL15 (SKF Flowline Monitor)	32–1 000	0,1–15	0.2–32	2, 4, 6, 8, 10	10	145	0 to +65	32 to 150	56
FL50 (SKF Flowline Monitor)	32–1 000	15–50	32.0–106	1, 2	10	145	0 to +65	32 to 150	56
FL100 (SKF Flowline Monitor)	32–1 000	50–100	106–211	1	10	145	0 to +65	32 to 150	56

¹⁾ depending on the operating viscosity

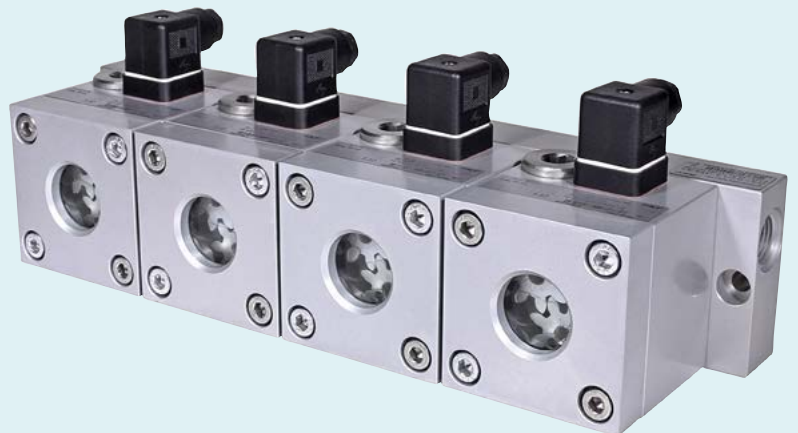
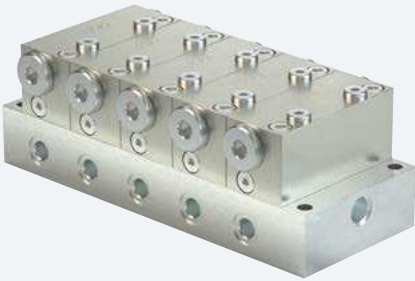
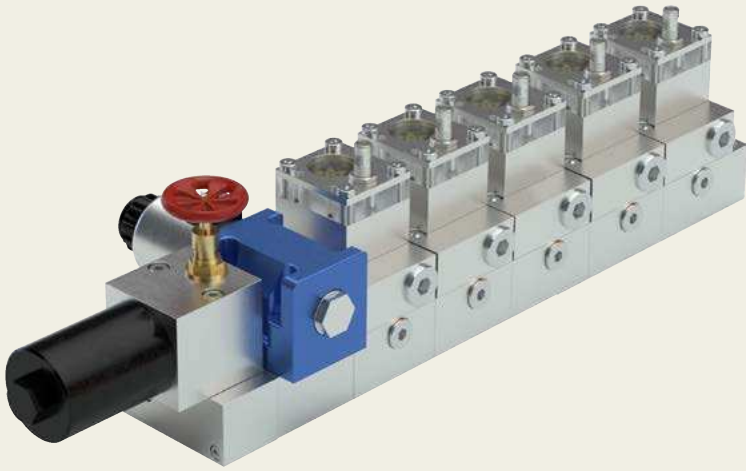

Overview of oil circulation metering devices

Pressure-compensated flow limiter with optional monitoring

Product	Lubricant viscosity	Flow rate		Outlets	Operating pressure		Operating temperature		Page
		mm ² /s	l/min		pts/min	bar	psi	°C	
SMBM-X	20–600	0,08–7,98	0.17–16.86	1–6	5–200	73–2 900	0 to 70	32 to 158	58
SMBM-V	20–600	0,08–7,98	0.17–16.86	1–6	5–200	73–2 900	0 to 70	32 to 158	60
SMB 3	20–600	6,0–38	12.7–80	1	5–200	73–2 900	0 to 100	32 to 212	62
SMB 13	20–600	6,0–30	12.7–63.4	1	6–50	87–725	0 to 70	32 to 158	64
SMB 6	20–600	25–132	53–279	1	5–200	73–2 900	0 to 100	32 to 212	66
SMB 14	20–600	25–132	52.8–278.9	1	6–50	87–725	0 to 70	32 to 158	68

Modular progressive metering devices

Product	Lubricant viscosity	Flow rate		Outlets	Operating pressure max.		Operating temperature		Page
		mm ² /s	l/min		pts/min	bar	psi	°C	
PSG1	> 12	0–0,8	0–1.7	6–20	200	2 900	-15 to +110	5 to 230	70
PSG2	> 12	0–2,5	0–5.3	6–20	200	2 900	-15 to +110	5 to 230	72
PSG3	> 12	0–6	0–12.7	6–20	200	2 900	-15 to +110	5 to 230	74
VP	> 12	0–1	0–2.1	6–20	200	2 900	-25 to +90	-13 to +194	76

Screw-in restrictor

VD



Description

SKF screw-in flow restrictors VD are used to deliver relatively small amounts of oil to lubrication points. Four types of SKF VD are available, differing in tube diameter, flow rate and functionality. VD1 and VD4 restrictors can be combined and fit to manifolds, while VD2 and VD3 can be screwed directly into the ports of individual lubrication points. Screw-in restrictors VD3 and VD4 also come with a check valve to prevent leaks. These inexpensive flow restrictors are sensitive to dirt. Therefore, it is recommended to use a filter size of 10 µm.

Features and benefits

- Easy planning and flow rate regulation
- Flow rate dependent on pressure and viscosity
- Check valve to prevent leaks (VD3, VD4)
- Fitting to manifolds and combination of screw-in restrictors possible (VD1, VD4)
- Direct threading into ports of individual lubrication points possible (VD2, VD3)

Applications

- Machine tools
- Metal industry
- Presses
- Automation
- Industrial transmissions
- Automotive industry
- Heavy industry

Technical data

Function	screw-in restrictor
Outlets	1
Lubricant	mineral and PAO oils; viscosity 10–1 000 mm ² /s
Flow rate	0,001–0,23 l/min 0,002–0,49 pts/min
Operating temperature	0 to +60 °C; +32 to 140 °F
Operating pressure	10 bar; 145 psi
Filter	< 10 µm
Material	steel, brass
Main line connections:	
VD 1	M10×1
VD 2	M10×1 for tube Ø6 mm
VD 3	DIN 3862 fitting for tube Ø4 mm
VD 4	M8×1
Outlet connections:	
VD 1	M8×1 for tube Ø4 mm
VD 2	M10×1 (direct lub. point mounting)
VD 3	M10×1 tap (direct lub. point mounting)
VD 4	DIN 3862 fitting for tube Ø4 mm
	M8 or M10
Length:	
VD 1	30 mm; 1.18 in
VD 2	32 mm; 1.26 in
VD 3	32 mm; 1.26 in
VD 4	34 mm; 1.34 in
Mounting position	any



NOTE

Further technical information, technical drawings, accessories, spare parts or product function descriptions available on SKF.com/lubrication:

1-5006-EN



3D

skf-lubrication.partcommunity.com/3d-cad-models

Screw-in restrictor

VD

Order number	Tube Ø mm	Flow rate ¹⁾ at 2 bar		at 4 bar		at 6 bar		Description ²⁾	Code
		ml/min	pts/min	ml/min	pts/min	ml/min	pts/min		
VD1-102	4	1	0.0021	2,8	0.0059	4	0.0085	M10×1 for manifold mounting, washer 504-019	2
VD1-103	4	2,8	0.0059	5,5	0.0116	8	0.0169	M10×1 for manifold mounting, washer 504-019	3
VD1-104	4	5	0.0106	10	0.0211	15	0.0317	M10×1 for manifold mounting, washer 504-019	4
VD1-105	4	7,5	0.0158	15	0.0317	23	0.0486	M10×1 for manifold mounting, washer 504-019	5
VD1-106	4	15	0.0317	28	0.0592	40	0.0845	M10×1 for manifold mounting, washer 504-019	6
VD1-107	4	35	0.0739	68	0.1437	100	0.2113	M10×1 for manifold mounting, washer 504-019	7
VD1-108	4	58	0.1226	112	0.2367	170	0.3592	M10×1 for manifold mounting, washer 504-019	8
VD1-109	4	77	0.1627	155	0.3276	230	0.4860	M10×1 for manifold mounting, washer 504-019	9
VD2-102	6	1	0.0021	2,8	0.0059	4	0.0085	M10×1 for mounting direct into lubrication point	2
VD2-103	6	2,8	0.0059	5,5	0.0116	8	0.0169	M10×1 for mounting direct into lubrication point	3
VD2-104	6	5	0.0105	10	0.0211	15	0.0317	M10×1 for mounting direct into lubrication point	4
VD2-105	6	7,5	0.0159	15	0.0317	23	0.0486	M10×1 for mounting direct into lubrication point	5
VD2-109	6	77	0.1627	155	0.3276	230	0.4860	M10×1 for mounting direct into lubrication point	9
VD3-099	4	0,15	0.0003	0,28	0.0006	0,4	0.0008	M10×1 tab for mounting direct into lubrication point	00
VD3-100	4	0,3	0.0006	0,68	0.0014	1	0.0021	M10×1 tab for mounting direct into lubrication point	0
VD3-101	4	0,5	0.0011	1	0.0021	1,5	0.0032	M10×1 tab for mounting direct into lubrication point	1
VD3-102	4	1	0.0021	2	0.0042	3	0.0063	M10×1 tab for mounting direct into lubrication point	2
VD4-099	4	0,15	0.0003	0,28	0.0006	0,4	0.0008	M8×1 for manifold mounting, washer DIN 7603-A8x11,5-CU	00
VD4-100	4	0,3	0.0006	0,68	0.0014	1	0.0021	M8×1 for manifold mounting, washer DIN 7603-A8x11,5-CU	0

¹⁾ The shown flow rates are valid for an operating viscosity of 140 mm²/s. Flow rates change at the same time system pressure or lubricant viscosity change. Further details on request.
²⁾ Washer not included, but can be ordered separately

Accessories - manifold

Order code

Product series

Number of ports

Design of outlet thread

Material

Design of main line connection

V **L** -

01 = 1 port **03** = 3 ports **05** = 5 ports **08** = 8 ports
02 = 2 ports **04** = 4 ports **06** = 6 ports **10** = 10 ports

D = Small profile, M8×1 with counterbore for flat washer
 (can only be selected for main line connection M3)
F = Normal profile, M8×1 with counterbore for flat washer
G = Normal profile, M10×1 with counterbore for flat washer

A = Aluminum;
E = Stainless steel (only for outlet threads A, B, E, G)

G1 = G 1/8 to DIN 3852-2, Form X, small
G2 = G 1/4 to DIN 3852-2, Form X, small
M1 = M10×1 to DIN 3852-1, Form X, small
M2 = M14×1.5 to DIN 3852-1, Form X, small
M3 = M10×1 with counterbore for solderless pipe connection per DIN 3862
M4 = M14×1.5 with counterbore for solderless pipe connection per DIN 3862

Order example



VL-02FAM3

- Product series VL
- 2 ports
- Normal profile made of aluminum
- M8×1 internal thread with counterbore for flat washer
- M10×1 main line connection with counterbore for solderless pipe connection per DIN 3862

Flow divider

SMT



Description

The SKF flow divider SMT 1 splits the flow rate into two equal flows or into two individual flows at a specific ratio. Different defined dividing ratios are available from 1:1 to 1:4. Because the SMT 1 flow divider regulates itself, varying back pressures have negligible impact on the dividing accuracy. The SMT 1 is distinguished by its simple and compact design for installation near the lubrication point. Due to its corrosion-resistant material, it also can be utilized in aggressive environments. Additionally, this flow divider can be used with a wide range of viscosities from 50–1 300 mm²/s.

Features and benefits

- Compact design for installation near lubrication point
- High accuracy due to self-regulating feature
- Corrosion resistant
- Easy flow adjustment (nozzle exchange)
- Inexpensive monitoring through upstream pressure switch or flow controller possible

Applications

- Automotive
- Pulp and paper industry
- On-off road
- Machine tools
- Metal fabrication
- Power plants



Technical data

Function	flow divider
Outlets	2
Operating temperature	0 to +100 °C; +32 to 212 °F
Operating pressure	100 bar; 1 450 psi
Lubricant	mineral and synthetic oils; viscosity 50–1 300 mm ² /s
Flow rate	0,5–6,0 l/min 1,05–12,7 pts/min
Dividing ratios	1:1; 1:1,5; 1:2; 1:2,5; 1:3; 1:3,5; 1:4
Dividing accuracy	≥ 95 %
Material	aluminium, anodized
Dimensions	30 × 69 × 58 mm 1,18 × 2,72 × 2,28 in
with inline strainer	87 × 69 × 108 mm 3,43 × 2,72 × 4,25 in
Mounting position	any

NOTE

Further technical information, technical drawings, accessories, spare parts or product function descriptions available on SKF.com/lubrication:
1-5017-EN; 1-5006-EN

Flow divider

SMT

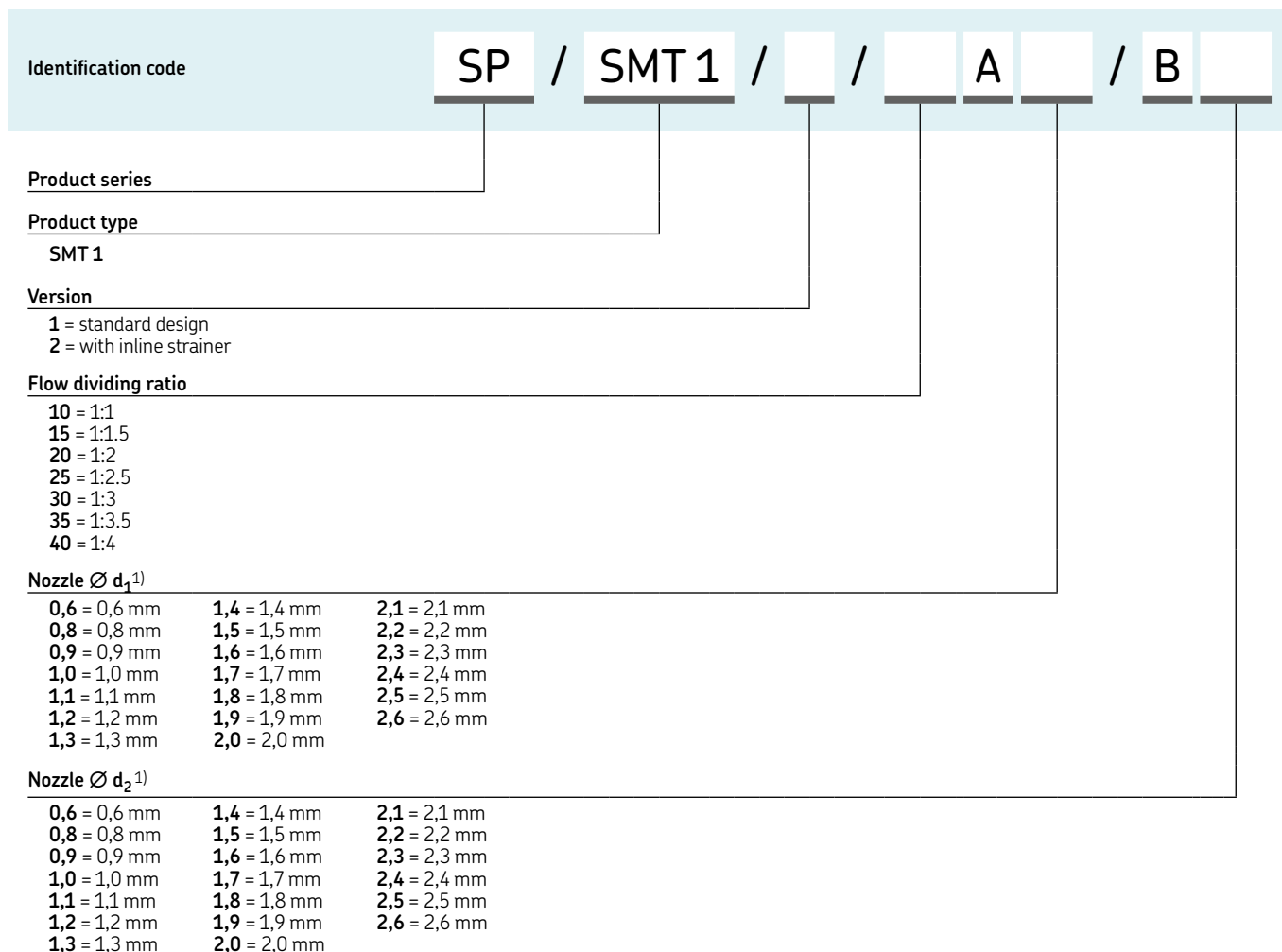

¹⁾ Nozzle diameters d1 and d2 need to be determined using a diagram, see brochure 1-5017. Identification code positions A and B are three-digit numbers representing the nozzle sizes. The code for the example would be: d1 (0.9 mm) = 090 and for d2 (1.4 mm) = 140

Adjustable restrictor

242



Description

The SKF adjustable restrictors 242 are used if a subsequent adjustment of the flow rate is required. The restrictors come in three versions, differing in metering quantity, visual flow indication and number of outlets. Type A flow rates are within the drop-feed range of 0 to 0,01 l/min (0 to 0.02 pts). The adjustable restrictor 242 offers 1 to 14 outlets and a sight-glass for flow rate monitoring. Type B offers continuous metering quantity from 0,01 to 1,0 l/min (0.02 to 2.11 pts) and comes with 2 to 12 outlets. Type C metering quantity ranges from 0,01 to 2,0 l/min (0.02 to 4.23 pts). Depending on the distributor, 2 to 6 outlets are available. Types B and C offer a spring-loaded metal pin in the sight-glass for visual oil flow monitoring.

Features and benefits

- Easy adjustable
- Easy planning and quantity regulation
- Cost-effective visual oil flow monitoring
- Individual regulation of flow range for each lubrication point
- Wide viscosity range

Applications

- Oil and Gas
- Machine tools
- Metal fabrication
- Metal forming
- Textiles

Technical data

Function	adjustable restrictor
Lubricant	mineral and synthetic oils; viscosity 10–1 000 mm ² /s
Outlets:	
Design A	1, 2, 5, 14
Design B	2, 3, 4, 5, 6, 10, 12
Design C	2 to 6
Metering quantity:	
Design A	0 to 0.01 l/min; 0 to 0.02 pts/min
Design B	0.01 to 1.0 l/min; 0.02 to 2.11 pts/min
Design C	0.01 to 2.0 l/min; 0.02 to 4.23 pts/min
Operating temperature	0 to +60 °C; +32 to 140 °F
Operating pressure	max. 10 bar max. 145 psi
Filter	< 10 µm
Material	steel
Connection:	
Design A + B	M10×1 for tube 6 mm
Design C	M16×1,5 for tube 10 mm
Dimension:	
depending on model	min. 93 × 16 × 32 mm max. 97 × 25 × 253 mm min. 3.66 × 0.63 × 1.29 in max. 3.82 × 0.98 × 9.96 in
Mounting position:	
Design B + C	any
Design A	sight glass vertical, above the lubrication point

NOTE

Further technical information, technical drawings, accessories, spare parts or product function descriptions available on SKF.com/lubrication:

1-5006-EN



3D

skf-lubrication.partcommunity.com/3d-cad-models

Adjustable restrictor

242



242-026.00

242 Type A

Metering quantity: 0–10 cm³; 0–0.6 in³

Order number	Outlets
242-016.00	1
242-026.00	2
242-056.00	5
242-146.00	14



242-124.00

242 Type B

Metering quantity: 10–1 000 cm³; 0.6–61 in³

Order number	Outlets
242-024.00	2
242-034.00	3
242-044.00	4
242-054.00	5
242-064.00	6
242-104.00	10
242-124.00	12

Indicating at 110 mm²/s; start at 10, end at 1 000 or 2 000 cm³/min



242-044.004

242 Type C

Metering quantity: 10–2 000 cm³; 0.6–122 in³

Order number	Outlets
242-025.00	2
242-035.00	3
242-045.00	4
242-055.00	5
242-065.00	6

Indicating at 110 mm²/s; start at 10, end at 1 000 or 2 000 cm³/min

Accessories

242 Type A and B, main tube connector and accessories

Order number	Designation	Tube
		Ø mm
406-162	main tube connector	6
408-162	main tube connector	8
410-162	main tube connector	10
408-211	screw plug	–
508-215-CU	washer	–

242 Type C, main tube connector and accessories

Order number	Designation	Tube
		Ø mm
410-018	main tube connector	10
412-018	main tube connector	12
412-011	screw plug	–
DIN7603-A18x22-CU	washer	–

Flow meter

SKF Variolub



Description

SKF Variolub SMD flow meters are designed to meter and monitor the flow in oil circulation lubrication systems. They are offered in three different versions covering a flow rate of 0,05 to 40 l/min. The flow meters can be adjusted by a built-in adjustment valve. The meters provide visual and electronic monitoring, and the by-pass system allows adjustment and service, even while the system is running. Due to their modular design, SMD flow meters can be easily replaced, adapted and expanded. They are suitable for machines with several hundred lubrication points and provide reliability and flexibility.

Features and benefits

- High accuracy and robust design
- Easy maintenance and reduced downtime due to bypass system
- Modular system enables flow rate changes and system extension
- Many industry interfaces available

Applications

- Pulp and paper industry
- Machine tools
- Metal industry
- Heavy industry

Technical data

Function	gear wheel flow meter
Outlets	SMD 2: 2 SMD 3: 1
Lubricant	mineral and synthetic oils; viscosity 50–650 mm ² /s
Flow rate	
SMD 2:	0,1–8,0 l/min; 0,2–16,9 pts/min
SMD 3:	4,0–40,0 l/min; 8,5–84,5 pts/min
Operating temperature	0 to +70 °C +32 to 158 °F
Operating pressure	16 bar 232 psi
Material	housing: anodized aluminium lid: PMMA gear wheels: GPR SMD3 :GPR / aluminum
Inlet connection	G 3/4 BSPP; G 1 1/16-12 UN
Outlet connection	
SMD2:	G 3/8 BSPP; G 9/16-18 UN
SMD3:	G 3/4 BSPP; G 1 1/16-12 UN
Protection class	IP 65
Dimensions	
SMD 2	90 × 70 × 150 mm 3.54 × 2.7 × 5.91 in
SMD 3	110 × 130 × 150 mm 4.33 × 5.1 × 5.91 in
Mounting position	any
Options	connection block, shut-off block, flushing port



NOTE

Further technical information, technical drawings, accessories, spare parts or product function descriptions available on SKF.com/lubrication:

1-3021-EN

Flow meter

SKF Variolub

Variolub SMD

Type	Designation	Outlets	Flow rate		Order number	
			l/min	pts/min	Connection thread BSPP	UN / UNF
SMD 2	2 fine adjustment valves	2	2 × 0,1–4,4	2 × 0.2–9.3	24-2581-2656-ZH	24-2581-2615
SMD 2	2 coarse adjustment valves	2	2 × 4,0–8,0	2 × 8.5–16.9	24-2581-2657-ZH	24-2581-2617
SMD 2	1 fine adjustment valve (top) 1 coarse adjustment valve (down)	2	1 × 0,1–4,4 1 × 4,0–8,0	1 × 0.2–9.3 1 × 8.5–16.9	24-2581-2658-ZH	24-2581-2616
SMD 3	1 high volume adjustment valve	1	1 × 4,0–40	1 × 8.5–84.5	24-2581-2652-ZH	24-2581-2693

Variolub SMD bank mounting components

Type	Designation	Order number	
		Connection thread BSPP	UN / UNF
SMD 2	connection block complete	24-1503-2103	–
SMD 2	shut-off block complete	–	on request
SMD 2/3	plug screws G 3/4 BSPP; DIN 908 1.1/16–12 UN	95-0034-0908	–
SMD 2/3	seal A27 × 32 DIN 7603 Cu	209-10617-3	–

Variolub SMD Accessories

Type	Designation	Order number	
		Connection thread BSPP	UN / UNF
SMD 2	spare part kit	24-9909-0178-ZH	24-9909-0178-ZH
SMD 3	spare part kit	24-9909-0179	24-9909-0179
SMD 2	seal kit	24-0404-2520	24-0404-2520
SMD 3	seal kit	24-0404-2521	24-0404-2521
SMD 2	mounting screw 4 × ¹⁾	DIN912-M6×60-8.8D2R	DIN912-M6×60-8.8D2R
SMD 3	mounting screw 4 × ¹⁾	DIN912-M6×45-8.8D2R	DIN912-M6×45-8.8D2R

¹⁾ Mounting screw is included in delivery of SMD 2

Flow meter

SKF Safeflow



Description

SKF Safeflow flow meters control and indicate the flow rate in oil circulation lubrication systems. Each flow meter can be calibrated individually according to oil viscosity and desired flow. SKF Safeflow covers a flow rate of 0,04 to 56 l/min (0.08–118 pts/min) per lubrication point and can be banked (up to 10 units wide) to reduce piping and simplify installation. These flow meters offer excellent readability and visual monitoring due to their operating principle of straight glass flow tubes with internal calibration cones.

Features and benefits

- Easy and individual calibration of flow meters with adjustable flow rate
- SF05A, SF10A and SF15A can be combined in one module on request
- Common or individual electronic alarms available

Applications

- Pulp and paper industry
- Metal industry
- Power plants
- Mining

Technical data

Function Lubricant	variable area flow meter mineral and synthetic oils; viscosity 30–1 000 mm ² /s
Flow rate	0,04–56 l/min; 0.08–118 pts/min
Operating temperature	0 to +70 °C; +32 to 158 °F
Operating pressure	16 bar; 230 psi
Outlets	1–10
Material	aluminum, glass
Electrical alarm: Power supply	24V DC (22–36 V DC) or 24V AC (18–27 V AC RMS)
Power consumption	max. 150 mA
Alarm output	dry contact relay output max. load 50 VAC/DC, 1A IP65
Protection class	
Dimensions: SF05A/10A/15A	min. 170 × 97 × 170 mm max. 170 × 97 × 566 mm min. 6.69 × 3.82 × 6.69 in max. 6.69 × 3.82 × 22.28 in
SF20	min. 250 × 94 × 74 mm max. 250 × 94 × 324 mm min. 9.84 × 3.70 × 2.91 in max. 9.84 × 3.70 × 13.46 in
SF30	275 × 100 × 129 mm 10.83 × 3.94 × 5.08 in
Mounting position	horizontal



NOTE

Further technical information, technical drawings, accessories, spare parts or product function descriptions available on SKF.com/lubrication: **6409/2**



3D

skf-lubrication.partcommunity.com/3d-cad-models

Flow meter

SKF Safeflow

Identification code	<table border="1" style="margin: auto;"> <tr> <td style="padding: 5px;">SF</td> <td style="padding: 5px;"></td> <td style="padding: 5px;">A</td> <td style="padding: 5px;"></td> <td style="padding: 5px;"></td> <td style="padding: 5px;"></td> <td style="padding: 5px;"></td> <td style="padding: 5px;"></td> </tr> </table>	SF		A					
SF		A							
Product types									
SF = Safeflow									
Flow rate per flow meter									
05 = 100 mm ² /s: 0,1–0,7 l/min; 0.2–1.5 pts/min 220 mm ² /s: 0,04–0,35 l/min; 0.08–0.74 pts/min									
10 = 100 mm ² /s: 0,1–3,0 l/min; 0.2–6.3 pts/min 220 mm ² /s: 0,1–1,7 l/min; 0.08–0.74 pts/min									
15 = 100 mm ² /s: 0,3–7,2 l/min; 0.6–15.2 pts/min 220 mm ² /s: 0,2–4,4 l/min; 0.4–9.3 pts/min									
20 = 100 mm ² /s: 1,3–17,0 l/min; 2.7–35.9 pts/min 220 mm ² /s: 0,6–10,6 l/min; 5.3–93.0 pts/min									
30 = 100 mm ² /s: 5,0–56,0 l/min; 10.6–118.3 pts/min 220 mm ² /s: 2,5–44,0 l/min; 5.3–93.0 pts/min									
Calibration cone									
A = adjustable cone									
Outlets									
1 = 1, SF05A–SF30A 2 = 2, SF05A–SF20A 4 = 4, SF05A–SF20A	6 = 6, SF05A–SF20A 8 = 8, SF05A–SF15A 10 = 10, SF05A–SF15A								
Connection ports									
R = BSPP U = NPT									
Alarm electrical (Alarm units for SF20A and SF30A must be ordered separately)									
X = no alarm A = with electrical alarm									
Alarm type									
BSC = common alarm BSS = individual alarm									

Alarm units for Safeflow SF20A and SF30A¹⁾

Order number	Designation
13128390	BSC-12030 (common alarm)
13128395	BSS-12030 (individual alarm)

¹⁾ Must be ordered separately



BSC-12030

Safeflow connections

Products	Outlets	Connection inlet		Outlet connection
		group size 1	group size 2-10	
		BSPP / NPT	BSPP / NPT	BSPP / NPT
SF05A	1, 2, 4, 6, 8, 10	1/2	1	1/2
SF10A	1, 2, 4, 6, 8, 10	1/2	1	1/2
SF15A	1, 2, 4, 6, 8, 10	1/2	1	1/2
SF20A	1, 2, 4, 6	1/2	1	3/4
SF30A	1	1 1/4	1	1 1/4

Flow meter

SKF Flowline Monitor



Description

The SKF Flowline Monitor is used to divide, measure and control the flow rate in oil circulation lubrication systems. Three different flow meter sizes enable control and monitoring of 0,1 to 100 l/min flows with operating viscosities from 32 to 1 000 mm²/s. The flow meters operate individually and can be programmed and adjusted separately. Regardless of oil temperature and viscosity changes, the SKF Flowline Monitor provides accurate results. Computer configuration and remote monitoring are possible. Monitoring modules are available offering common alarms, individual alarms for each lubrication point and interfaces to process controls.

Features and benefits

- Extended product service life due to improved adjustment valve surface coating
- Minimal pressure loss due to turbine-based monitoring and adjusting-valve technology
- Easy-to-use interface
- Indication of flow accuracy of each lubrication point
- Modular monitoring capabilities
- Panel mounting possible

Applications

- Pulp and paper industry
- Metal industry
- Mining
- Power plants
- Other industries and applications

Technical data

Function	turbine flow meter
Lubricant	mineral, synthetic or environmentally friendly oils with a viscosity of 32–1 000 mm ² /s
Flow meters:	
FL15	2, 4, 6, 8, 10
FL50	1 or 2
FL 100	1
Flow rate:	
FL15	0,1–15 l/min; 0,2–32 pts/min
FL50	15–50 l/min; 32–105 pts/min
FL100	50–100 l/min; 105–210 pts/min
Operating temperature	0 to + 65 °C; +32 to 150 °F
Operating pressure	max. 10 bar; 145 psi
Power supply	20–36 V DC 24 V AC (–20 to + 5%)
Power consumption	5 W
Alarm relay	potential free contact; max. load 30V DC / 1 A, 120V AC / 1 A, resistive load
Inlet connection	depending on model
Outlet connection	G / NPT 1; G / NPT 2x1
Protection class	G / NPT 1/2; G / NPT 1 1/4
Dimensions	IP 65 min. 150 × 106 × 226 mm max. 150 × 230 × 618 mm min. 5.9 × 4.17 × 8.9 in max. 5.9 × 9.05 × 24.33 in



NOTE

Further technical information, technical drawings, accessories, spare parts or product function descriptions available on SKF.com/lubrication:

17075 EN



3D

skf-lubrication.partcommunity.com/3d-cad-models

Flow meter

SKF Flowline Monitor

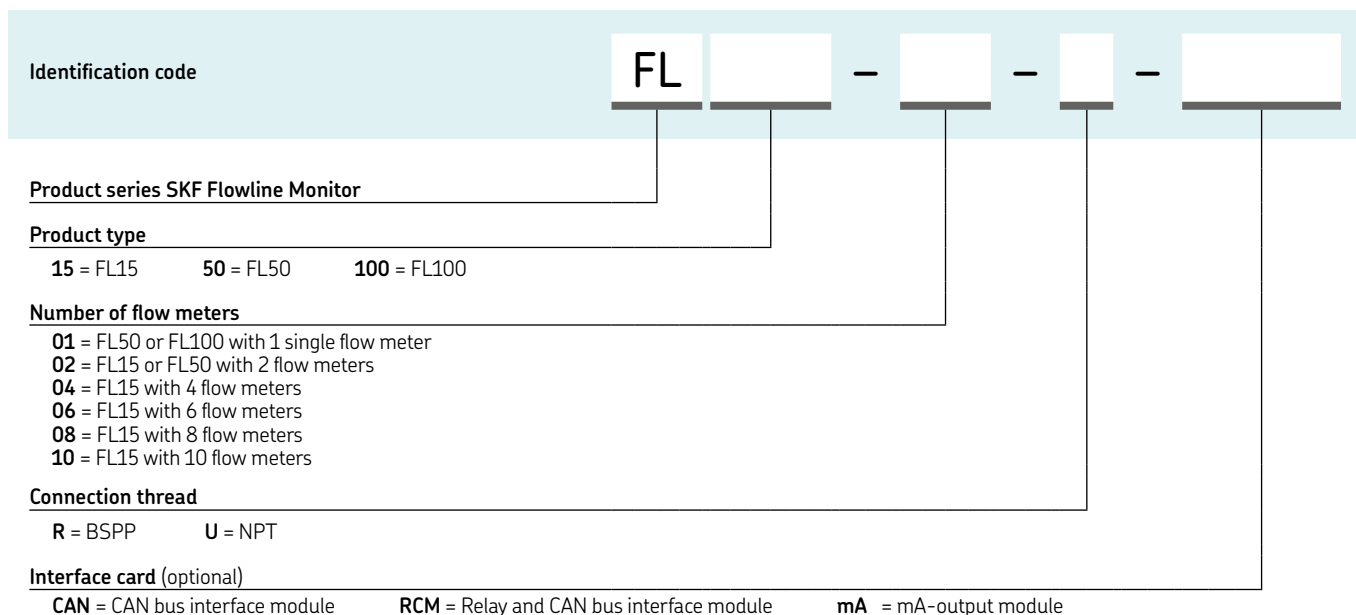

Flow meters with BSPP connection thread

Order number	Designation	Number of flow meters	Interface card
13120202	FL15-02-R	2	alarm relay output
13120204	FL15-04-R	4	alarm relay output
13120206	FL15-06-R	6	alarm relay output
13120208	FL15-08-R	8	alarm relay output
13120210	FL15-10-R	10	alarm relay output
13120300	FL50-R	1	alarm relay output
13120316	FL50-02-R	2	alarm relay output
13127800	FL100-01-R	1	alarm relay output
13120212	FL15-02-R-CAN	2	CAN bus module
13120214	FL15-04-R-CAN	4	CAN bus module
13120216	FL15-06-R-CAN	6	CAN bus module
13120218	FL15-08-R-CAN	8	CAN bus module
13120220	FL15-10-R-CAN	10	CAN bus module
13120310	FL50-R-CAN	1	CAN bus module
13120317	FL50-02-R-CAN	2	CAN bus module
13127808	FL100-01-R-CAN	1	CAN bus module
13120342	FL15-02-R-RCM	2	Relay & CAN bus module
13120344	FL15-04-R-RCM	4	Relay & CAN bus module
13120346	FL15-06-R-RCM	6	Relay & CAN bus module
13120348	FL15-08-R-RCM	8	Relay & CAN bus module
13120350	FL15-10-R-RCM	10	Relay & CAN bus module
13120312	FL50-R-RCM	1	Relay & CAN bus module
13120318	FL50-02-R-RCM	2	Relay & CAN bus module
13127802	FL100-01-R-RCM	1	Relay & CAN bus module
13120362	FL15-02-R-mA	2	analogue module
13120364	FL15-04-R-mA	4	analogue module
13120366	FL15-06-R-mA	6	analogue module
13120368	FL15-08-R-mA	8	analogue module
13120370	FL15-10-R-mA	10	analogue module
13120314	FL50-R-mA	1	analogue module
13120319	FL50-02-R-mA	2	analogue module
13127804	FL100-01-R-mA	1	analogue module
13120180	FL-100 OUTLET BLOCK G1 1/4	-	-

Flow meters with NPT connection thread

Order number	Designation	Number of flow meters	Interface card
13120222	FL15-02-U	2	alarm relay output
13120224	FL15-04-U	4	alarm relay output
13120226	FL15-06-U	6	alarm relay output
13120228	FL15-08-U	8	alarm relay output
13120230	FL15-10-U	10	alarm relay output
13120320	FL50-U	1	alarm relay output
13120336	FL50-02-U	2	alarm relay output
13127810	FL100-01-U	1	alarm relay output
13120232	FL15-02-U-CAN	2	CAN bus module
13120234	FL15-04-U-CAN	4	CAN bus module
13120236	FL15-06-U-CAN	6	CAN bus module
13120238	FL15-08-U-CAN	8	CAN bus module
13120240	FL15-10-U-CAN	10	CAN bus module
13120330	FL50-U-CAN	1	CAN bus module
13120337	FL50-02-U-CAN	2	CAN bus module
13127810	FL100-01-U-CAN	1	CAN bus module
13120352	FL15-02-U-RCM	2	Relay & CAN bus module
13120354	FL15-04-U-RCM	4	Relay & CAN bus module
13120356	FL15-06-U-RCM	6	Relay & CAN bus module
13120358	FL15-08-U-RCM	8	Relay & CAN bus module
13120360	FL15-10-U-RCM	10	Relay & CAN bus module
13120331	FL50-U-RCM	1	Relay & CAN bus module
13120338	FL50-02-U-RCM	2	Relay & CAN bus module
13127812	FL100-01-U-RCM	1	Relay & CAN bus module
13120372	FL15-02-U-mA	2	analogue module
13120374	FL15-04-U-mA	4	analogue module
13120376	FL15-06-U-mA	6	analogue module
13120378	FL15-08-U-mA	8	analogue module
13120380	FL15-10-U-mA	10	analogue module
13120334	FL50-U-mA	1	analogue module
13120339	FL50-02-U-mA	2	analogue module
13127816	FL100-01-U-mA	1	analogue module
13120182	FL-100 OUTLET BLOCK NPT1 1/4	-	-

Flow limiter

SMBM-X (Single-flow)



Description

The SMBM-X is a 1–6 outlets flow regulating valve with fixed output based on pressure balance. It is designed to divide main line flows into parallel, individual, volumetric flow quantities and to “limit” these according to requirements. The flow is generated independently of system pressure changes and virtually independently of viscosity, guaranteeing a constant flow. The SMBM-X provides a flow rate from 0,08 to 7,89 l/min (0.17–16.86 pts/min) and a pressure range of up to 200 bar (2 900 psi). It has three selectable built-in monitoring options, a gear-wheel-type flow indicator, a signal transmitter or a piston detector. All three monitoring options enable electronic monitoring of the current flow.

Features and benefits

- Effective monitoring of oil flow
- Self-adjusting metering with constant oil flow independent of back pressures
- Modular design with 3 different monitoring options (gear meter, signal transmitter or piston detector)
- Wide viscosity range - virtually independent of viscosity
- Ideal solution for small labyrinth sealed bearings
- ATEX versions available

Applications

- Pulp and paper industry
- Mining industry
- Heavy industry

Technical data

Function	2-way flow regulating valve with a fixed set-point, incl. filter
Outlets	1–6
Lubricant	mineral and synthetic oils; viscosity 20–600 mm ² /s
Flow rate ¹⁾	0,08–7,98 l/min 0.17–16.89 pts/min
Operating temperature	0 to +70 °C +32 to 158 °F
Filter mesh size	0,1 mm (100 micron)
Monitoring options	gear meter with pulse sensor, signal transmitter or piston detector (go/no-go signal)
Operating pressure	
SMBM with gear meter	5–200 bar; 72.5–2 900 psi
SMBM with signal transmitter	5–100 bar; 72.5–1 450 psi
SMBM with piston detector	5–85 bar; 72.5–1 230 psi
Differential pressure	>5 bar; >72.5 psi
Material	EN AW-6061-T651, anodized
Connection port	G ¹ / ₂ BSPP
Protection class	IP 65 (pulse sensor and piston detector IP 67)
Mounting position	vertical

¹⁾ For technical reasons oil output of the system's feeding pump must be >10–15% of all flow limiters flow rates mounted in the system. Higher metering quantities available on request



NOTE

Further technical information, technical drawings, accessories, spare parts or product function descriptions available on SKF.com/lubrication:

18872EN

Flow limiter

SMBM-X (Single-flow)

Identification code (one outlet module)

SMB M - X [] XX []

Product series

Type of monitoring

11 = gear meter and standard sensor (max. admissible nozzle index 295)
 21 = signal transmitter 24 V DC, incl. LED
 31 = with piston detector
 (further monitoring options on request)

Flow rate - nozzle index¹⁾

050 = 0,08 l/min (0.17 pts/min)	120 = 0,98 l/min (2.07 pts/min)	190 = 2,80 l/min (5.92 pts/min)	260 = 5,37 l/min (11.35 pts/min)
055 = 0,12 l/min (0.25 pts/min)	125 = 1,09 l/min (2.30 pts/min)	195 = 2,98 l/min (6.30 pts/min)	265 = 5,55 l/min (11.73 pts/min)
060 = 0,15 l/min (0.32 pts/min)	130 = 1,18 l/min (2.49 pts/min)	200 = 3,16 l/min (6.68 pts/min)	270 = 5,77 l/min (12.19 pts/min)
065 = 0,20 l/min (0.42 pts/min)	135 = 1,30 l/min (2.75 pts/min)	205 = 3,30 l/min (6.97 pts/min)	275 = 5,99 l/min (12.66 pts/min)
070 = 0,25 l/min (0.53 pts/min)	140 = 1,43 l/min (3.02 pts/min)	210 = 3,43 l/min (7.25 pts/min)	280 = 6,22 l/min (13.15 pts/min)
075 = 0,29 l/min (0.61 pts/min)	145 = 1,56 l/min (3.30 pts/min)	215 = 3,58 l/min (7.57 pts/min)	285 = 6,49 l/min (13.72 pts/min)
080 = 0,35 l/min (0.74 pts/min)	150 = 1,67 l/min (3.53 pts/min)	220 = 3,79 l/min (8.01 pts/min)	290 = 6,74 l/min (14.24 pts/min)
085 = 0,41 l/min (0.87 pts/min)	155 = 1,79 l/min (3.87 pts/min)	225 = 3,98 l/min (8.22 pts/min)	295 = 6,95 l/min (14.69 pts/min)
090 = 0,47 l/min (0.99 pts/min)	160 = 1,92 l/min (4.06 pts/min)	230 = 4,18 l/min (8.83 pts/min)	300 = 7,17 l/min (15.15 pts/min)
095 = 0,56 l/min (1.18 pts/min)	165 = 2,07 l/min (4.37 pts/min)	235 = 4,37 l/min (9.24 pts/min)	305 = 7,31 l/min (15.45 pts/min)
100 = 0,65 l/min (1.37 pts/min)	170 = 2,21 l/min (4.67 pts/min)	240 = 4,57 l/min (9.66 pts/min)	310 = 7,48 l/min (15.81 pts/min)
105 = 0,73 l/min (1.54 pts/min)	175 = 2,36 l/min (4.99 pts/min)	245 = 4,80 l/min (10.14 pts/min)	315 = 7,72 l/min (16.32 pts/min)
110 = 0,79 l/min (1.67 pts/min)	180 = 2,52 l/min (5.33 pts/min)	250 = 5,00 l/min (10.57 pts/min)	320 = 7,98 l/min (16.86 pts/min)
115 = 0,88 l/min (1.86 pts/min)	185 = 2,67 l/min (5.66 pts/min)	255 = 5,19 l/min (10.67 pts/min)	

¹⁾ All oil flow rates related to the indicated nozzle sizes were determined for a service viscosity of 300 mm²/s at a temperature of 20 °C (68 °F). They are approximative values and may need to be adapted to different viscosities shown on SKF.com/SMBM or in publication 18872EN.

Order information collector

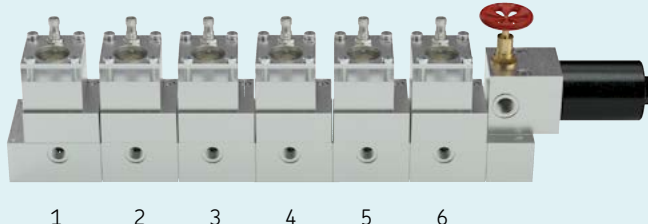

Number of modules

(1–6 modules possible, further options on request)

Module 1

(please transfer the identification code from the configurator shown above)

SMB M - X [] XX []

Module 2

(please transfer the identification code from the configurator shown above)

SMB M - X [] XX []

Module 3

(please transfer the identification code from the configurator shown above)

SMB M - X [] XX []

Module 4

(please transfer the identification code from the configurator shown above)

SMB M - X [] XX []

Module 5

(please transfer the identification code from the configurator shown above)

SMB M - X [] XX []

Module 6

(please transfer the identification code from the configurator shown above)

SMB M - X [] XX []

Flow limiter

SMBM-V (Dual-flow)

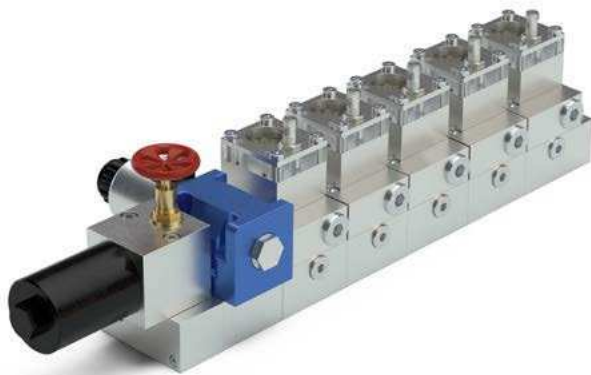

Description

The SMBM-V is a 1–6 outlets flow regulating valve with fixed output based on pressure balance. It is designed to divide main line flows into parallel, individual, volumetric flow quantities and to “limit” these according to requirements. The flow is generated independently of system pressure changes and virtually independently of viscosity, guaranteeing a constant flow. The SMBM-V provides a flow rate from 0,08 to 7,98 l/min (0.17–16.86 pts/min) and a pressure range of up to 200 bar (2 900 psi). During start-up, the flow is reduced to 25% of the nominal flow, to avoid leakages in small labyrinth sealed bearings. It has three selectable built-in monitoring options, a gear-wheel-type flow indicator, a signal transmitter or a piston detector. All three monitoring options enable electronic monitoring of the current flow. SMBM-V is the technically optimized successor of SMB 7 and SMB 10.

Features and benefits

- Effective monitoring of oil flow
- Ideal solution for small labyrinth sealed bearings
- Dual flow design to enable start-up flow reduction
- Self-adjusting metering with constant oil flow independent of back pressures
- Modular design with 3 different monitoring options (gear meter, signal transmitter or piston detector)
- Wide viscosity range - virtually independent of viscosity
- ATEX versions available

Applications

- Pulp and paper industry
- Heavy and mining industry

Technical data

Function	2-way flow regulating valve with two fixed set-point based on pressure balance, use with change-over valve, incl. filter
Outlets	1–6
Lubricant	mineral and synthetic oils; viscosity 20–600 mm ² /s
Flow rate ¹⁾	0,08–7,98 l/min 0.17–16.86 pts/min
Operating temperature	0 to +70 °C +32 to 158 °F
Filter mesh size	0,1 mm (100 micron)
Monitoring options	gear meter with pulse sensor, signal transmitter or piston detector (go/no-go signal)
Operating pressure	
SMBM with gear meter	5–200 bar; 72.5–2 900 psi
SMBM with signal transmitter	5–100 bar; 72.5–1 450 psi
SMBM with piston detector	5–85 bar; 72.5–1 230 psi
Differential pressure	>5 bar; >72.5 psi
Material	EN AW-6061-T651, anodized
Connection port	G1/2 BSPP
Protection class	IP 65 (pulse sensor and piston detector IP 67)
Mounting position	vertical

¹⁾ For technical reasons oil output of the system's feeding pump must be > 10–15% of all flow limiters flow rates mounted in the system. Higher metering quantities available on request



NOTE

Further technical information, technical drawings, accessories, spare parts or product function descriptions available on SKF.com/lubrication:

18872EN

Flow limiter

SMBM-V (Dual-flow)

Identification code (one outlet module)

SMB	M	-	V		XX	
-----	---	---	---	--	----	--

Product series

Type of monitoring

- 11 = gear meter and standard sensor (max. admissible nozzle index 295)
- 21 = signal transmitter 24 V DC, incl. LED
- 31 = with piston detector

(further monitoring options on request)

Flow rate - nozzle index 1)

001 = 0,12 : 0,47 l/min (0.25 : 0.99 pts/min)	014 = 0,79 : 3,43 l/min (1.67 : 7.25 pts/min)
002 = 0,12 : 0,56 l/min (0.25 : 1.18 pts/min)	015 = 0,88 : 3,79 l/min (1.86 : 8.01 pts/min)
003 = 0,15 : 0,65 l/min (0.32 : 1.37 pts/min)	016 = 0,98 : 4,37 l/min (2.07 : 9.24 pts/min)
004 = 0,20 : 0,79 l/min (0.25 : 1.67 pts/min)	017 = 1,09 : 4,57 l/min (2.30 : 9.66 pts/min)
005 = 0,25 : 0,98 l/min (0.82 : 2.07 pts/min)	018 = 1,18 : 5,00 l/min (2.49 : 10.57 pts/min)
006 = 0,29 : 1.18 l/min (0.61 : 2.49 pts/min)	019 = 1,30 : 5,37 l/min (2.75 : 11.35 pts/min)
007 = 0,35 : 1,43 l/min (0.74 : 3.02 pts/min)	020 = 1,43 : 5,77 l/min (3.02 : 12.19 pts/min)
008 = 0,41 : 1,67 l/min (0.87 : 3.53 pts/min)	021 = 1,56 : 6,22 l/min (3.30 : 13.15 pts/min)
009 = 0,47 : 1,92 l/min (0.99 : 4.06 pts/min)	022 = 1,67 : 6,74 l/min (3.53 : 13.24 pts/min)
010 = 0,56 : 2,21 l/min (1.18 : 4.67 pts/min)	023 = 1,79 : 7,17 l/min (3.87 : 15.15 pts/min)
011 = 0,56 : 2,52 l/min (1.18 : 5.33 pts/min)	024 = 1,79 : 7,48 l/min (3.87 : 15.81 pts/min)
012 = 0,65 : 2,80 l/min (1.37 : 5.92 pts/min)	025 = 1,92 : 7,98 l/min (4.06 : 16.86 pts/min)
013 = 0,73 : 3,16 l/min (1.54 : 6.68 pts/min)	

¹⁾ All oil flow rates related to the indicated nozzle sizes were determined for a service viscosity of 300 mm²/s at a temperature of 20 °C (68 °F). They are approximative values and may need to be adapted to different viscosities shown on SKF.com/SMBM or in publication 18872EN.

Order information collector

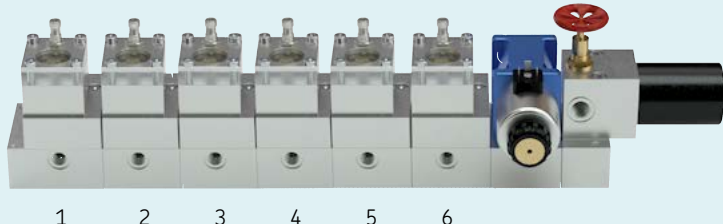

Number of modules

(1–6 modules possible, further options on request)

Module 1

(please transfer the identification code from the configurator shown above)

Module 2

(please transfer the identification code from the configurator shown above)

Module 3

(please transfer the identification code from the configurator shown above)

Module 4

(please transfer the identification code from the configurator shown above)

Module 5

(please transfer the identification code from the configurator shown above)

Module 6

(please transfer the identification code from the configurator shown above)

SMB	M	-	V		XX	
SMB	M	-	V		XX	
SMB	M	-	V		XX	
SMB	M	-	V		XX	
SMB	M	-	V		XX	
SMB	M	-	V		XX	

Flow limiter

SMB 3



Description

The SKF SMB 3 flow limiter is designed to divide the main line flow into parallel, individual flows. The flow is generated independently of system pressure changes and virtually independently of viscosity, guaranteeing a constant flow. The SMB 3 provides a flow rate from 6 to 38 l/min (12.6–80.3 pts/min) and a pressure range of up to 200 bar. The flow limiter offers oil flow monitoring with a signal transmitter or piston detector. These indicators create a fault signal when the flow rate drops to approximately 85%. The SMB 3 flow limiter is a perfect solution for applications with changing ambient temperatures and the need for a stable oil flow such as in oil circulation lubrication systems.

Features and benefits

- Stable oil flow rate regardless of pressure, temperature or viscosity changes
- No need for system pressure control, a pressure relief valve is sufficient
- Simple monitoring by signal transmitter
- Easy start-up with fixed flow rate via pre-selected nozzle sizes
- Adaptation of flow rates by plug-in nozzles
- High operating temperature up to +100 °C
- Optional ATEX version Ex II 3 cll CT6
- Extremely robust design

Applications

- Mining, Cement and Oil & Gas industry
- Metal forming, machine tools
- Pulp & Paper industry
- Industrial gearboxes



Technical data

Function	flow limiter
Outlets	1
Lubricant	environmentally friendly mineral and synthetic oils; viscosity 20–600 mm ² /s
Flow rate ¹⁾	6–38 l/min; 12.6–80.3 pts/min
Operating temperature	0 to +100 °C; +32 to 212 °F
Operating pressure ²⁾	5–200 bar 72–2 900 psi
Differential pressure	>5 bar >72 psi
Material	gray cast iron, zinc coated
Connection	M12×1; 4-poles coupler socket
Protection class	IP 65
Signal sensors E4/E5	24 V to 230 V AC/DC
Proximity switch E6	12 to 36 VDC; IP 67
Dimensions	min. 40 × 90 × 138 mm max. 40 × 90 × 245 mm min. 1.57 × 3.54 × 5.43 in max. 1.57 × 3.54 × 9.63 in
Mounting position	any, preferably vertical

¹⁾ For technical reasons oil output of the system's feeding pump must be > 10–15% of all flow limiters flow rates mounted in the system.

²⁾ See further details under monitoring SMB3/6/8



NOTE

Further technical information, technical drawings, accessories, spare parts or product function descriptions available on SKF.com/lubrication:

1-3001-EN

Flow limiter

SMB 3

Identification code	24	-	27	03	-		-																																					
Product series	SMB																																											
Product type	03 = SMB 3																																											
Type of monitoring	0 = without monitoring 6 = with piston detector E6		7 = with signal transmitter E4 8 = with signal transmitter E5																																									
Flow rate - nozzle index ¹⁾	<table border="0"> <tr> <td>250 = 6,00 l/min (12.6 pts/min)</td> <td>370 = 12,00 l/min (25.3 pts/min)</td> <td>490 = 20,25 l/min (42.8 pts/min)</td> </tr> <tr> <td>260 = 6,50 l/min (13.7 pts/min)</td> <td>380 = 12,75 l/min (26.9 pts/min)</td> <td>500 = 21,00 l/min (44.3 pts/min)</td> </tr> <tr> <td>270 = 6,75 l/min (14.2 pts/min)</td> <td>390 = 13,50 l/min (28.5 pts/min)</td> <td>510 = 21,75 l/min (45.9 pts/min)</td> </tr> <tr> <td>280 = 7,00 l/min (14.8 pts/min)</td> <td>400 = 14,00 l/min (29.5 pts/min)</td> <td>520 = 22,50 l/min (47.5 pts/min)</td> </tr> <tr> <td>290 = 7,50 l/min (15.9 pts/min)</td> <td>410 = 14,75 l/min (31.1 pts/min)</td> <td>530 = 23,25 l/min (49.1 pts/min)</td> </tr> <tr> <td>300 = 8,00 l/min (16.9 pts/min)</td> <td>420 = 15,50 l/min (32.7 pts/min)</td> <td>540 = 24,00 l/min (50.7 pts/min)</td> </tr> <tr> <td>310 = 8,75 l/min (18.5 pts/min)</td> <td>430 = 16,00 l/min (33.8 pts/min)</td> <td>550 = 25,00 l/min (52.8 pts/min)</td> </tr> <tr> <td>320 = 9,25 l/min (19.5 pts/min)</td> <td>440 = 16,75 l/min (35.4 pts/min)</td> <td>570 = 26,50 l/min (56.0 pts/min)</td> </tr> <tr> <td>330 = 9,75 l/min (20.6 pts/min)</td> <td>450 = 17,50 l/min (36.9 pts/min)</td> <td>580 = 28,00 l/min (59.1 pts/min)</td> </tr> <tr> <td>340 = 10,50 l/min (22.1 pts/min)</td> <td>460 = 18,00 l/min (38.0 pts/min)</td> <td>600 = 30,00 l/min (63.4 pts/min)</td> </tr> <tr> <td>350 = 11,00 l/min (23.2 pts/min)</td> <td>470 = 18,75 l/min (39.6 pts/min)</td> <td>650 = 34,00 l/min (71.8 pts/min)</td> </tr> <tr> <td>360 = 11,50 l/min (24.3 pts/min)</td> <td>480 = 19,50 l/min (41.2 pts/min)</td> <td>690 = 38,00 l/min (80.3 pts/min)</td> </tr> </table>								250 = 6,00 l/min (12.6 pts/min)	370 = 12,00 l/min (25.3 pts/min)	490 = 20,25 l/min (42.8 pts/min)	260 = 6,50 l/min (13.7 pts/min)	380 = 12,75 l/min (26.9 pts/min)	500 = 21,00 l/min (44.3 pts/min)	270 = 6,75 l/min (14.2 pts/min)	390 = 13,50 l/min (28.5 pts/min)	510 = 21,75 l/min (45.9 pts/min)	280 = 7,00 l/min (14.8 pts/min)	400 = 14,00 l/min (29.5 pts/min)	520 = 22,50 l/min (47.5 pts/min)	290 = 7,50 l/min (15.9 pts/min)	410 = 14,75 l/min (31.1 pts/min)	530 = 23,25 l/min (49.1 pts/min)	300 = 8,00 l/min (16.9 pts/min)	420 = 15,50 l/min (32.7 pts/min)	540 = 24,00 l/min (50.7 pts/min)	310 = 8,75 l/min (18.5 pts/min)	430 = 16,00 l/min (33.8 pts/min)	550 = 25,00 l/min (52.8 pts/min)	320 = 9,25 l/min (19.5 pts/min)	440 = 16,75 l/min (35.4 pts/min)	570 = 26,50 l/min (56.0 pts/min)	330 = 9,75 l/min (20.6 pts/min)	450 = 17,50 l/min (36.9 pts/min)	580 = 28,00 l/min (59.1 pts/min)	340 = 10,50 l/min (22.1 pts/min)	460 = 18,00 l/min (38.0 pts/min)	600 = 30,00 l/min (63.4 pts/min)	350 = 11,00 l/min (23.2 pts/min)	470 = 18,75 l/min (39.6 pts/min)	650 = 34,00 l/min (71.8 pts/min)	360 = 11,50 l/min (24.3 pts/min)	480 = 19,50 l/min (41.2 pts/min)	690 = 38,00 l/min (80.3 pts/min)
250 = 6,00 l/min (12.6 pts/min)	370 = 12,00 l/min (25.3 pts/min)	490 = 20,25 l/min (42.8 pts/min)																																										
260 = 6,50 l/min (13.7 pts/min)	380 = 12,75 l/min (26.9 pts/min)	500 = 21,00 l/min (44.3 pts/min)																																										
270 = 6,75 l/min (14.2 pts/min)	390 = 13,50 l/min (28.5 pts/min)	510 = 21,75 l/min (45.9 pts/min)																																										
280 = 7,00 l/min (14.8 pts/min)	400 = 14,00 l/min (29.5 pts/min)	520 = 22,50 l/min (47.5 pts/min)																																										
290 = 7,50 l/min (15.9 pts/min)	410 = 14,75 l/min (31.1 pts/min)	530 = 23,25 l/min (49.1 pts/min)																																										
300 = 8,00 l/min (16.9 pts/min)	420 = 15,50 l/min (32.7 pts/min)	540 = 24,00 l/min (50.7 pts/min)																																										
310 = 8,75 l/min (18.5 pts/min)	430 = 16,00 l/min (33.8 pts/min)	550 = 25,00 l/min (52.8 pts/min)																																										
320 = 9,25 l/min (19.5 pts/min)	440 = 16,75 l/min (35.4 pts/min)	570 = 26,50 l/min (56.0 pts/min)																																										
330 = 9,75 l/min (20.6 pts/min)	450 = 17,50 l/min (36.9 pts/min)	580 = 28,00 l/min (59.1 pts/min)																																										
340 = 10,50 l/min (22.1 pts/min)	460 = 18,00 l/min (38.0 pts/min)	600 = 30,00 l/min (63.4 pts/min)																																										
350 = 11,00 l/min (23.2 pts/min)	470 = 18,75 l/min (39.6 pts/min)	650 = 34,00 l/min (71.8 pts/min)																																										
360 = 11,50 l/min (24.3 pts/min)	480 = 19,50 l/min (41.2 pts/min)	690 = 38,00 l/min (80.3 pts/min)																																										
ATEX	ATEX = on request, only for ATEX (EX II 3cll CT6), without monitoring or with signal transmitter E5																																											

¹⁾ at an operating viscosity of 300 mm²/s

SMB 3 spare parts

Order number	Designation	Order number	Designation
24-1072-2113	E4 signal transmitter signal transmitter without coupler socket	179-990-600	socket straight, 4-pole, M12×1 with orange cable, 5 m
24-1072-2115		179-990-601	
24-1882-2151	signal transmitter with coupler socket with LED 24 V DC		socket angled, 4-pole, M12×1 with orange cable, 5 m
	coupler socket with LED 24 V DC		
24-1072-2113	E5 signal transmitter signal transmitter without coupler socket	24-1883-2081	Monitoring Flow limiter without nozzle, without signal transmitter
24-1072-2114			
24-1882-2121			
	signal transmitter with coupler socket without LED 230 V AC/DC		
	coupler socket without LEDs		

Flow limiter

SMB 13



Description

The SMB 13 flow limiter is designed to divide the main line flow into parallel, individual, volumetric flow quantities and to “limit” these according to requirements. The flow is generated independently of system pressure and virtually independently of viscosity, guaranteeing a constant flow. The SMB 13 provides a flow rate from 6 to 30 l/min (12.6–63.4 pts/min) and a pressure range up to 50 bar (725 psi). The flow limiter has a built-in, gear-wheel-type flow indicator for electronic and visual monitoring of oil flow. Every rotation creates a signal offering information about the flow rate. The SMB 13 flow limiter is a perfect solution for applications with changing ambient temperatures and the need for a stable oil flow such as in oil circulation lubrication systems.

Features and benefits

- Stable oil flow rate regardless of pressure, temperature or viscosity changes
- Visual and electronic monitoring with real flow indication
- Easy start-up with fixed flow rate via pre-selected nozzle sizes
- Adaptation of flow rates by plug-in nozzles
- Optional ATEX version for Ex II 2G c TX Gb, Ex II 2D c TX Db
- Optional connection to customer data control system
- Extremely robust design

Applications

- Mining, Cement and Oil & Gas industry
- Metal forming, machine tools
- Pulp & Paper industry
- Industrial gearboxes



Technical data

Function	flow limiter 2-way with volumetric flow control
Outlets	1
Lubricant	environmentally friendly, mineral and synthetic oils; viscosity 20–600 mm ² /s
Flow rate ¹⁾	6,0–30 l/min; 12.7–63.4 pts/min
Operating temperature	0 to +70 °C; +32 to 158 °F
Operating pressure	6–50 bar 87–725 psi
Differential pressure	>6 bar >87 psi
Material	AlCuPb F38, neutrally anodized
Electrical sensor	Hall sensor
Voltage	24 V DC ± 10%
Current switch	max. 20 mA
Connection	plug, DIN 43 650
Protection class	IP 65
Dimension	115 × 120 × 128,5 mm 4.53 × 4.72 × 5.06 in
Mounting position	any

¹⁾ For technical reasons oil output of the system's feeding pump must be > 10–15% of all flow limiters flow rates mounted in the system.



NOTE

Further technical information, technical drawings, accessories, spare parts or product function descriptions available on SKF.com/lubrication:

1-3004-EN; 951-180-072 EN

Flow limiter

SMB 13

Identification code	24 - 27 13 - - -																																				
Product series	24-27 = SMB																																				
Product design	13 = SMB 13																																				
Type of monitoring	0 = without monitoring 1 = with electrical monitoring 2 = with electrical monitoring for ATEX 3 = without electrical monitoring for ATEX																																				
Flow rate - nozzle index ¹⁾	<table border="0"> <tr> <td>250 = 6,00 l/min (12.6 pts/min)</td> <td>370 = 12,00 l/min (25.4 pts/min)</td> <td>490 = 20,25 l/min (42.8 pts/min)</td> </tr> <tr> <td>260 = 6,50 l/min (13.7 pts/min)</td> <td>380 = 12,75 l/min (26.9 pts/min)</td> <td>500 = 21,00 l/min (44.4 pts/min)</td> </tr> <tr> <td>270 = 6,75 l/min (14.2 pts/min)</td> <td>390 = 13,50 l/min (28.5 pts/min)</td> <td>510 = 21,75 l/min (45.9 pts/min)</td> </tr> <tr> <td>280 = 7,00 l/min (14.8 pts/min)</td> <td>400 = 14,00 l/min (29.6 pts/min)</td> <td>520 = 22,50 l/min (47.6 pts/min)</td> </tr> <tr> <td>290 = 7,50 l/min (15.6 pts/min)</td> <td>410 = 14,75 l/min (31.1 pts/min)</td> <td>530 = 23,25 l/min (49.1 pts/min)</td> </tr> <tr> <td>300 = 8,00 l/min (16.9 pts/min)</td> <td>420 = 15,50 l/min (32.8 pts/min)</td> <td>540 = 24,00 l/min (50.7 pts/min)</td> </tr> <tr> <td>310 = 8,75 l/min (18.5 pts/min)</td> <td>430 = 16,00 l/min (33.8 pts/min)</td> <td>550 = 25,00 l/min (52.8 pts/min)</td> </tr> <tr> <td>320 = 9,25 l/min (19.5 pts/min)</td> <td>440 = 16,75 l/min (35.4 pts/min)</td> <td>560 = 26,00 l/min (54.9 pts/min)</td> </tr> <tr> <td>330 = 9,25 l/min (20.6 pts/min)</td> <td>450 = 17,50 l/min (36.9 pts/min)</td> <td>570 = 27,00 l/min (57.0 pts/min)</td> </tr> <tr> <td>340 = 10,50 l/min (22.1 pts/min)</td> <td>460 = 18,00 l/min (38.0 pts/min)</td> <td>580 = 28,00 l/min (59.1 pts/min)</td> </tr> <tr> <td>350 = 11,00 l/min (23.2 pts/min)</td> <td>470 = 18,75 l/min (39.6 pts/min)</td> <td>600 = 30,00 l/min (63.4 pts/min)</td> </tr> <tr> <td>360 = 11,50 l/min (24.3 pts/min)</td> <td>480 = 19,50 l/min (41.2 pts/min)</td> <td></td> </tr> </table>	250 = 6,00 l/min (12.6 pts/min)	370 = 12,00 l/min (25.4 pts/min)	490 = 20,25 l/min (42.8 pts/min)	260 = 6,50 l/min (13.7 pts/min)	380 = 12,75 l/min (26.9 pts/min)	500 = 21,00 l/min (44.4 pts/min)	270 = 6,75 l/min (14.2 pts/min)	390 = 13,50 l/min (28.5 pts/min)	510 = 21,75 l/min (45.9 pts/min)	280 = 7,00 l/min (14.8 pts/min)	400 = 14,00 l/min (29.6 pts/min)	520 = 22,50 l/min (47.6 pts/min)	290 = 7,50 l/min (15.6 pts/min)	410 = 14,75 l/min (31.1 pts/min)	530 = 23,25 l/min (49.1 pts/min)	300 = 8,00 l/min (16.9 pts/min)	420 = 15,50 l/min (32.8 pts/min)	540 = 24,00 l/min (50.7 pts/min)	310 = 8,75 l/min (18.5 pts/min)	430 = 16,00 l/min (33.8 pts/min)	550 = 25,00 l/min (52.8 pts/min)	320 = 9,25 l/min (19.5 pts/min)	440 = 16,75 l/min (35.4 pts/min)	560 = 26,00 l/min (54.9 pts/min)	330 = 9,25 l/min (20.6 pts/min)	450 = 17,50 l/min (36.9 pts/min)	570 = 27,00 l/min (57.0 pts/min)	340 = 10,50 l/min (22.1 pts/min)	460 = 18,00 l/min (38.0 pts/min)	580 = 28,00 l/min (59.1 pts/min)	350 = 11,00 l/min (23.2 pts/min)	470 = 18,75 l/min (39.6 pts/min)	600 = 30,00 l/min (63.4 pts/min)	360 = 11,50 l/min (24.3 pts/min)	480 = 19,50 l/min (41.2 pts/min)	
250 = 6,00 l/min (12.6 pts/min)	370 = 12,00 l/min (25.4 pts/min)	490 = 20,25 l/min (42.8 pts/min)																																			
260 = 6,50 l/min (13.7 pts/min)	380 = 12,75 l/min (26.9 pts/min)	500 = 21,00 l/min (44.4 pts/min)																																			
270 = 6,75 l/min (14.2 pts/min)	390 = 13,50 l/min (28.5 pts/min)	510 = 21,75 l/min (45.9 pts/min)																																			
280 = 7,00 l/min (14.8 pts/min)	400 = 14,00 l/min (29.6 pts/min)	520 = 22,50 l/min (47.6 pts/min)																																			
290 = 7,50 l/min (15.6 pts/min)	410 = 14,75 l/min (31.1 pts/min)	530 = 23,25 l/min (49.1 pts/min)																																			
300 = 8,00 l/min (16.9 pts/min)	420 = 15,50 l/min (32.8 pts/min)	540 = 24,00 l/min (50.7 pts/min)																																			
310 = 8,75 l/min (18.5 pts/min)	430 = 16,00 l/min (33.8 pts/min)	550 = 25,00 l/min (52.8 pts/min)																																			
320 = 9,25 l/min (19.5 pts/min)	440 = 16,75 l/min (35.4 pts/min)	560 = 26,00 l/min (54.9 pts/min)																																			
330 = 9,25 l/min (20.6 pts/min)	450 = 17,50 l/min (36.9 pts/min)	570 = 27,00 l/min (57.0 pts/min)																																			
340 = 10,50 l/min (22.1 pts/min)	460 = 18,00 l/min (38.0 pts/min)	580 = 28,00 l/min (59.1 pts/min)																																			
350 = 11,00 l/min (23.2 pts/min)	470 = 18,75 l/min (39.6 pts/min)	600 = 30,00 l/min (63.4 pts/min)																																			
360 = 11,50 l/min (24.3 pts/min)	480 = 19,50 l/min (41.2 pts/min)																																				
ATEX	ATEX = on request, only for ATEX (EX II 2G c TX Gb, EX II 2D c TX Db), without monitoring or with piston detector																																				

¹⁾ at an operating viscosity of 300 mm²/s

SMB 13 flow limiter

Order number	Designation
24-1883-3016	SMB 13 without nozzle, with electrical monitoring

SMB 13 accessories

Order number	Designation
44-0758-2049	sight glass D45x12
24-0404-2310	gasket set: gasket D32/45x05 O-ring 44x3 O-ring 90x3
24-1882-2029	socket

Flow limiter

SMB 6



Description

The SMB 6 flow limiter is designed to divide the main line flow into parallel, individual, flows. The flow is generated independently of system pressure changes and virtually independently of viscosity, guaranteeing a constant flow. The SMB 6 provides a flow rate from 25 to 132 l/min (52.8–279 pts/min) and a pressure range of up to 200 bar (2 900 psi). The flow limiter offers oil flow monitoring with a signal transmitter or piston detector. These indicators create a fault signal when the flow rate drops to approximately 85%. The SMB 6 flow limiter is a perfect solution for applications with changing ambient temperatures and the need for a stable oil flow such as in oil circulation lubrication systems.

Features and benefits

- Stable oil flow rate regardless of pressure, temperature or viscosity changes
- Easy start-up with fixed flow rate via pre-selected nozzle sizes
- Adaptation of flow rates by plug-in nozzles
- High operating temperature up to +100 °C
- Simple monitoring by signal transmitter
- Extremely robust design
- Optional ATEX version

Applications

- Mining, Cement and Oil & Gas industry
- Metal forming, machine tools
- Pulp & Paper industry
- Industrial gearboxes

Technical data

Function	flow limiter
Outlets	1
Lubricant	environmentally friendly, mineral and synthetic oils; viscosity 20–600 mm ² /s
Flow rate ¹⁾	25–132 l/min 52.8–279 pts/min
Operating temperature	0 to +100 °C; +32 to 212 °F
Operating pressure ²⁾	5–200 bar 72–2 900 psi
Differential pressure	>5 bar >72 psi
Material	gray cast iron, zinc coated
Connection	M12×1; 4-poles coupler socket
Protection class	IP 65
Signal sensors E4/E5	24 V to 230 V AC/DC; IP 65
Proximity switch E6	12 to 36 VDC; IP 67
Dimensions	min. 40 × 90 × 138 mm max. 40 × 90 × 245 mm min. 1.57 × 3.54 × 5.43 in max. 1.57 × 3.54 × 9.63 in
Mounting position	any, preferably vertical

¹⁾ For technical reasons oil output of the system's feeding pump must be > 10–15% of all flow limiters flow rates mounted in the system. Higher metering quantities available on request

²⁾ Operating pressure E4 / E5 with signal transmitter only 5–85 bar



NOTE

Further technical information, technical drawings, accessories, spare parts or product function descriptions available on SKF.com/lubrication:

1-3001-EN

Flow limiter

SMB 6

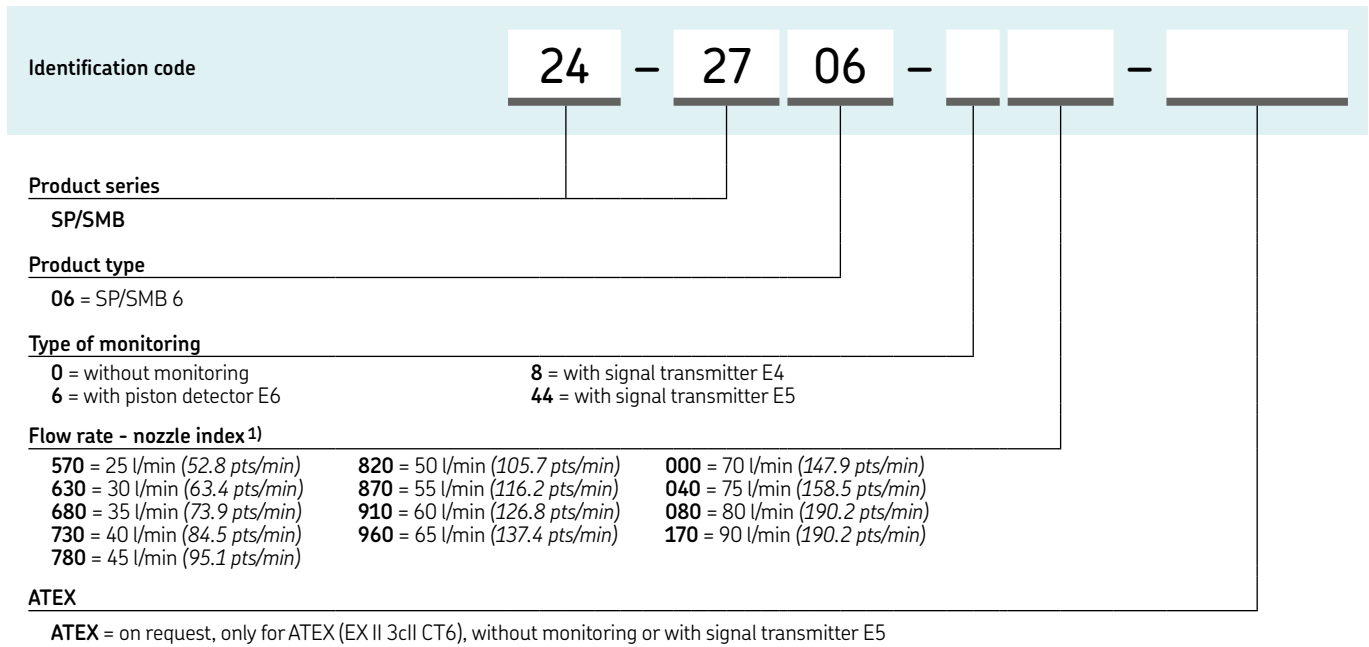

¹⁾ at an operating viscosity of 300 mm²/s

SMB 6 spare parts			
Order number	Designation	Order number	Designation
24-0712-6050	Flow limiter without nozzle, without signal transmitter	24-1072-2113 24-1072-2114	E5 signal transmitter signal transmitter without coupler socket signal transmitter with coupler socket without LED 230 V AC/DC coupler socket without LEDs
24-1072-2113 24-1072-2115	E4 signal transmitter signal transmitter without coupler socket signal transmitter with coupler socket with LED 24 V DC	24-1882-2121	
24-1882-2151	coupler socket with LED 24 V DC	179-990-600 179-990-601	E6 piston detector socket straight, 4-pole, M12x1 with orange cable, 5 m socket angled, 4-pole, M12x1 with orange cable, 5 m

Flow limiter

SMB 14



Description

The SMB 14 flow limiter is designed to divide the main line flow into parallel, individual, volumetric flow quantities and to “limit” these according to requirements. The flow is generated independently of system pressure and virtually independently of viscosity, guaranteeing a constant flow. The SMB 14 provides a flow rate from 25 to 100 l/min (52.8–211.3 pts/min) and a pressure range up to 50 bar (725 psi). It has a built-in, gear-wheel-type flow indicator for electronic and visual monitoring of oil flow. Every rotation creates a signal offering information about the flow rate. The SMB 14 flow limiter is a perfect solution for applications with changing ambient temperatures and the need for a stable oil flow such as in oil circulation lubrication systems.

Features and benefits

- Stable oil flow rate regardless of pressure, temperature or viscosity changes
- Visual and electronic monitoring with real flow indication
- Easy start-up with fixed flow rate via pre-selected nozzle sizes
- Adaptation of flow rates by plug-in nozzles
- Optional connection to customer data control system
- Extremely robust design
- Optional ATEX version

Applications

- Mining, Cement and Oil & Gas industry
- Metal forming, machine tools
- Pulp & Paper industry
- Industrial gearboxes



Technical data

Function	2-way flow limiter valve with volumetric flow check
Outlets	1
Lubricant	environmentally friendly, mineral and synthetic oils; viscosity 20–600 mm ² /s
Flow rate ¹⁾	25–132 l/min 52.8 - 278.9 pts/min
Operating temperature	0 to +70 °C +32 to 158 °F
Operating pressure	6–50 bar 87–725 psi
Differential pressure	>6 bar >87 psi
Material	AlCuPb F38, neutrally anodized
Electrical connection	hall sensor
Voltage	24 VDC ±10%
Current switch	max. 20 mA
Connection	plug, DIN 43 650
Protection class	IP 65
Dimensions	150 × 180 × 190 mm 5.91 × 7.09 × 7.48 in
Mounting position	any

¹⁾ For technical reasons oil output of the system's feeding pump must be > 10–15% of all flow limiters flow rates mounted in the system. Higher metering quantities available on request

NOTE

Further technical information, technical drawings, accessories, spare parts or product function descriptions available on SKF.com/lubrication:

1-3005-EN; 951-180-072 EN

Flow limiter

SMB 14

Identification code	24 - 27 14 - - -															
Product series	24-27 = SMB															
Product size	14 = SMB 14															
Type of monitoring	<p>0 = without monitoring, for nozzle index 570-960 1 = without monitoring, for nozzle index 000-170 2 = with electrical monitoring for ATEX 3 = without electrical monitoring for ATEX 4 = with electrical monitoring ¹⁾, (only for nozzle index 570-960) 5 = with electrical monitoring ¹⁾, (only for nozzle index 000-170)</p>															
Flow rate - nozzle index ²⁾	<table border="0"> <tr> <td>570 = 25 l/min (52 pts/min)</td> <td>820 = 50 l/min (105 pts/min)</td> <td>000 = 70 l/min (148 pts/min)</td> </tr> <tr> <td>630 = 30 l/min (63 pts/min)</td> <td>870 = 55 l/min (116 pts/min)</td> <td>040 = 75 l/min (158 pts/min)</td> </tr> <tr> <td>680 = 35 l/min (74 pts/min)</td> <td>910 = 60 l/min (126 pts/min)</td> <td>080 = 80 l/min (169 pts/min)</td> </tr> <tr> <td>730 = 40 l/min (84 pts/min)</td> <td>960 = 65 l/min (137 pts/min)</td> <td>170 = 90 l/min (190 pts/min)</td> </tr> <tr> <td>780 = 45 l/min (95 pts/min)</td> <td></td> <td></td> </tr> </table>	570 = 25 l/min (52 pts/min)	820 = 50 l/min (105 pts/min)	000 = 70 l/min (148 pts/min)	630 = 30 l/min (63 pts/min)	870 = 55 l/min (116 pts/min)	040 = 75 l/min (158 pts/min)	680 = 35 l/min (74 pts/min)	910 = 60 l/min (126 pts/min)	080 = 80 l/min (169 pts/min)	730 = 40 l/min (84 pts/min)	960 = 65 l/min (137 pts/min)	170 = 90 l/min (190 pts/min)	780 = 45 l/min (95 pts/min)		
570 = 25 l/min (52 pts/min)	820 = 50 l/min (105 pts/min)	000 = 70 l/min (148 pts/min)														
630 = 30 l/min (63 pts/min)	870 = 55 l/min (116 pts/min)	040 = 75 l/min (158 pts/min)														
680 = 35 l/min (74 pts/min)	910 = 60 l/min (126 pts/min)	080 = 80 l/min (169 pts/min)														
730 = 40 l/min (84 pts/min)	960 = 65 l/min (137 pts/min)	170 = 90 l/min (190 pts/min)														
780 = 45 l/min (95 pts/min)																
ATEX	ATEX = on request															

¹⁾ with electrical monitoring, (PNP technology, 24 V DC) continuous pulse sequence, proportional to volumetric flow
²⁾ at an operating viscosity of 300 mm²/s

SMB 14 flow limiter	
Order number	Designation
24-1883-3017	SMB 14 without nozzle, with electrical monitoring

SMB 14 accessories	
Order number	Designation
44-0758-2049	sight glass, D45x12
24-0404-2311	gasket set: gasket D32/45x05 O-ring 44x3 O-ring 90x3
24-1882-2029	socket

Progressive metering device

PSG1

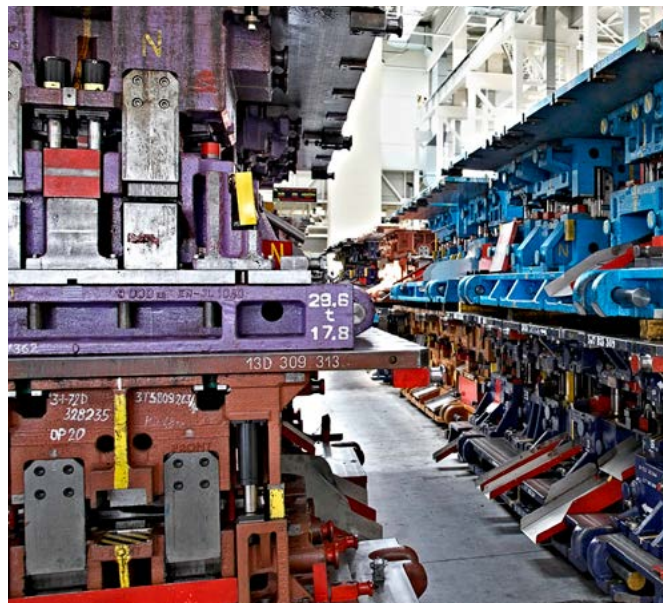

Description

The PSG1 is a progressive metering device consisting of a baseplate and different metering sections that can be individually combined for specific outlet ratios and cross portings. The ports are part of the baseplate, so that connectors and tubes remain in place when segments need to be changed.

Features and benefits

- Easy servicing as outlets are located on baseplate
- Flexible due to exchangeable metering segments
- Visual or electrical monitoring possible
- Dummy segments with no output available
- Adjustable by consolidating outlets internally or externally

Applications

- Automobile presses
- Paper machines
- Tunnel boring machines

Technical data

Function	segmented progressive metering device
Outlets	6 to 20
Lubricant	grease: up to NLGI 2 mineral and synthetic oils; min. viscosity 12 mm ² /s
Metering quantity	per cycle and outlet:
min.	0,05 cm ; 0.003 in
max.	0,25 cm ; 0.015 in
Flow rate	max. 0,8 l/min; 0.17 pts/min
Operating temperature	-15 to +110 °C; 5 to 230 °F
Operating pressure ¹⁾	200 bar; 2 900 psi
Material	
baseplate:	aluminum alloy
sections:	steel galvanized
Inlet connection	G 1/8
Outlet connection	G 1/8
Protection class	IP 67
Dimensions	min. 90 × 55 × 41 mm max. 244 × 55 × 41 mm min. 3.54 × 2.17 × 1.61 in max. 9.61 × 2.17 × 1.61 in
Mounting position:	
on machines without vibration	any
on machines with vibration	piston position should be 90° to machine's movement direction

¹⁾ Operating pressure may be lower depending on design with monitoring or attachments

PSG1 accessories

Order number	Designation
466-419-001	Closure plug for baseplate outlet incl. washer
24-2151-3760	Crossporting bridge, 2 outlets ¹⁾
24-2151-3762	Crossporting bridge, 2 outlets, with outlet port ¹⁾
24-2151-3764	Crossporting bridge, 2 outlets, with outlet port and check valve ¹⁾

¹⁾ bridges are approved for a maximum operating pressure of 100 bar; crossporting bridge also available for 3 outlets, see brochure

NOTE

Further technical information, technical drawings, accessories, spare parts or product function descriptions available on SKF.com/lubrication:
14389EN; 951-230-013



3D
skf-lubrication.partcommunity.com/3d-cad-models

Progressive metering device

PSG1

Identification code	PSG1	X	X	X				
Product series								
Monitoring								
X = none 3 = 3-pin piston detector, M12x1 plug Y = cycle indicator, visual plunger rod ^{1) 2)} S = cycle indicator with bracket and proximity switch ^{1) 2)} G = cycle indicator with bracket for proximity switch (without proximity switch) ^{1) 2)}								
Position of monitoring device ²⁾								
X = none A = left, section 1 B = right, section 1 C = left, section 2 D = right, section 2 E = left, section 3 F = right, section 3 G = left, section 4 H = right, section 4 J = left, section 5 K = right, section 5 L = left, section 6 M = right, section 6 N = left, section 7 P = right, section 7 Q = left, section 8 R = right, section 8 S = left, section 9 T = right, section 9 U = left, section 10 V = right, section 10								
Connector baseplate inlet ³⁾								
X = none A = tube Ø6 mm	B = tube Ø8 mm C = tube Ø10 mm							
Sections								

... = to be configured in the section configurator below

Identification code	-	-
Section (minimum 3 sections) ⁴⁾		
X = dummy section A = 0,05 cm ³ /cycle ⁵⁾ E = 0,25 cm ³ /cycle	B = 0,10 cm ³ /cycle D = 0,20 cm ³ /cycle	
Outlet connector left		
S = outlet closed by screw plug ⁶⁾ X = outlet without fitting		
Outlet connector right		
S = outlet closed by screw plug ⁶⁾ X = outlet without fitting		

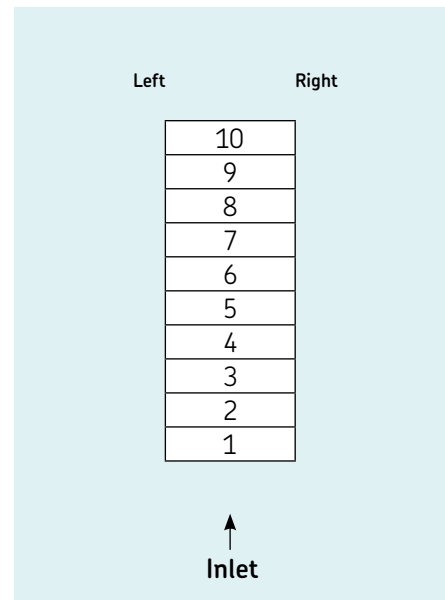

¹⁾ Only on 200 and 250 mm³ section sizes
²⁾ Installation on first or last section is not recommended
³⁾ Solderless pipe union with cutting sleeve per DIN 2353
⁴⁾ The volume per section is equal on both sides
⁵⁾ If possible, do not place in first position when designing metering device
⁶⁾ Metering device only operates with one side (left or right) outlet closed per section

Progressive metering device

PSG2

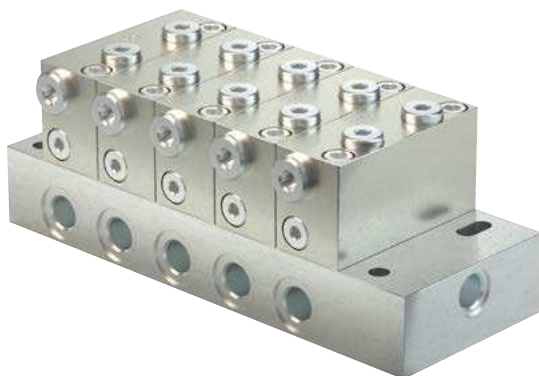

Description

The PSG2 is a progressive metering device consisting of a baseplate and different metering sections that can be individually combined for specific outlet ratios and cross portings. The ports are part of the baseplate, so that connectors and tubes remain in place when segments need to be changed.

Features and benefits

- Easy servicing due to outlet location
- Flexible with exchangeable metering segments
- Visual or electrical monitoring available
- Increased corrosion-resistant material
- Adjustable output by consolidating outlets internally or externally

Applications

- Automobile presses
- Tunnel boring machines
- Paper machines

Technical data

Function	segmented progressive metering device
Outlets	6 to 20
Lubricant	grease: up to NLGI 2 mineral and synthetic oils; min. viscosity of 12 mm ² /s
Metering quantity	per cycle and outlet:
min.	0,06 cm ³ ; 0.0037 in ³
max.	0,84 cm ³ ; 0.051 in ³
Flow rate	max. 2,5 l/min; 5.3 pts/min
Operating temperature	-15 to +110 °C; +5 to +230 °F
Operating pressure ¹⁾	200 bar; 2 900 psi
Material	
baseplate:	aluminium alloy or anodized
sections:	steel or nickel plated
Inlet connection	G 1/4
Outlet connection	G 1/4
Protection class	IP67
Dimensions	min. 131 × 86 × 71 mm max. 327 × 86 × 71 mm min. 5.16 × 3.39 × 2.80 in max. 12.87 × 3.39 × 2.80 in
Mounting position:	
on machines without vibration	any
on machines with vibration	piston position should be 90° to machine movement direction
Options	flow limiter

¹⁾ Operating pressure may be lower depending on design with monitoring or attachments

PSG2 accessories

Order number	Designation
466-419-001	Closure plug for baseplate outlet incl. washer
24-2151-3760	Crossporting bridge, 2 outlets ¹⁾
24-2151-3762	Crossporting bridge, 2 outlets, with outlet port ¹⁾
24-2151-3764	Crossporting bridge, 2 outlets, with outlet port and check valve ¹⁾

¹⁾ Bridges are approved for a maximum operating pressure of 100 bar; crossporting bridge also available for 3 outlets, see brochure



NOTE

Further technical information, technical drawings, accessories, spare parts or product function descriptions available on SKF.com/lubrication:

14389 EN; 951-230-01



3D

skf-lubrication.partcommunity.com/3d-cad-models

Progressive metering device

PSG2

Identification code	PSG2						X	
Product series								
Monitoring								
<ul style="list-style-type: none"> X = none 3 = 3-pin piston detector, M12x1 plug Y = cycle indicator, visual plunger rod ¹⁾ S = cycle indicator with bracket and proximity switch ¹⁾ G = cycle indicator with bracket for proximity switch (without proximity switch) ¹⁾ 								
Position of monitoring device ²⁾								
<ul style="list-style-type: none"> X = none A = left, section 1 C = left, section 2 E = left, section 3 G = left, section 4 J = left, section 5 L = left, section 6 N = left, section 7 Q = left, section 8 S = left, section 9 U = left, section 10 	<ul style="list-style-type: none"> B = right, section 1 D = right, section 2 F = right, section 3 H = right, section 4 K = right, section 5 M = right, section 6 P = right, section 7 R = right, section 8 T = right, section 9 V = right, section 10 							
Attachments								
<ul style="list-style-type: none"> F = SMB 8 flow limiter with nominal volume up to 1.56 l/min G = SMB 8 flow limiter with nominal volume from 1.67 l/min K = gear-type flow indicator 								
Plug-in nozzle for flow limiter								
see PUB 14389 EN; p. 15								
Connector baseplate inlet ³⁾								
<ul style="list-style-type: none"> X = none A = tube Ø6 mm B = tube Ø8 mm 			<ul style="list-style-type: none"> C = tube Ø10 mm D = tube Ø12 mm 					
Sections								

... = to be configured in the section configurator below

Section configurator ⁴⁾	-	-
Section (minimum 3 sections) ⁴⁾		
<ul style="list-style-type: none"> x = dummy section F = 0,06 cm³/cycle ⁵⁾ G = 0,12 cm³/cycle H = 0,24 cm³/cycle J = 0,36 cm³/cycle 	<ul style="list-style-type: none"> K = 0,48 cm³/cycle L = 0,60 cm³/cycle M = 0,72 cm³/cycle N = 0,84 cm³/cycle 	
Outlet connector left		
<ul style="list-style-type: none"> S = outlet closed by screw plug ⁶⁾ X = outlet without connector 		
Outlet connector right		
<ul style="list-style-type: none"> S = outlet closed by screw plug ⁶⁾ X = outlet without connector 		

Left	Right
10	
9	
8	
7	
6	
5	
4	
3	
2	
1	

↑
Inlet

¹⁾ Only on section sizes L (0,60 cm³)
²⁾ Installation on first or last section is not recommended
³⁾ Solderless pipe union with cutting sleeve per DIN 2353
⁴⁾ The volume per section is equal on both sides
⁵⁾ If possible, do not place in first position when designing metering device
⁶⁾ Metering device only operates with one side (left or right) outlet closed per section

Progressive metering device

PSG3

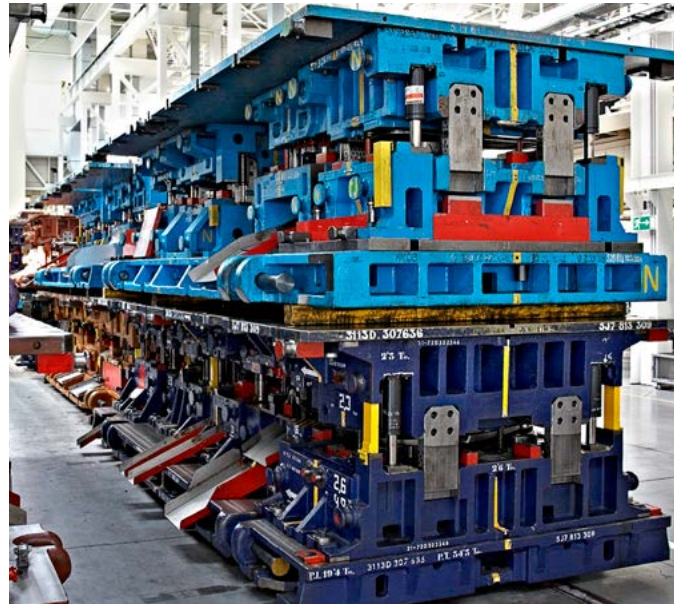
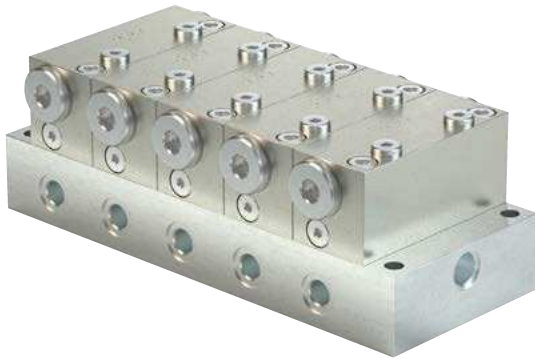

Description

The PSG3 is a progressive metering device consisting of a baseplate and different metering sections that can be individually combined for specific outlet ratios and cross portings. The ports are part of the baseplate, so that connectors and tubes remain in place when segments need to be changed.

Features and benefits

- Easy servicing as outlets are located on baseplate
- Flexible with exchangeable metering segments
- Visual or electrical monitoring available
- Increased corrosion-resistant material available
- Dummy segments without output available
- Adjustable output by consolidating outlets internally or externally
- Main metering device in oil circulation systems

Applications

- Automobile presses
- Paper machines
- Tunnel boring machines

Technical data

Function	segmented progressive metering device
Outlets	6 to 20
Lubricant	grease up to NLGI 2 mineral and synthetic oils; min. viscosity 12 mm ² /s
Metering quantity	per cycle and outlet:
min.	0,80 cm 0,049 in
max.	3,20 cm 0,195 in
Flow rate	max. 6 l/min; 12.7 pts/min
Operating temperature	-15 to +110 °C; +5 to +230 °F
Operating pressure ¹⁾	200 bar 2 900 psi
Material	
baseplate:	aluminium alloy or anodized
sections:	steel galvanized or nickel plated
Inlet connection	G 3/8
Outlet connection	G 1/4
Protection class	IP 67
Dimensions	min. 165 × 108 × 88 mm max. 466 × 108 × 88 mm min. 6.50 × 4.25 × 3.46 in max. 18.35 × 4.25 × 3.46 in
Mounting position:	
on machines without vibration	any
on machines with vibration	piston position must be in 90° angle to machine's movement direction
Options	flow limiter

¹⁾ Operating pressure may be lower depending on design with monitoring or attachments

PSG3 accessories

Order number	Designation
DIN908-R1-4-5.8	Closure plug for baseplate outlet
508-108	Washer for closure plug
24-2151-3734	Crossporting bridge, 2 outlets ¹⁾
24-2151-3736	Crossporting bridge, 2 outlets with outlet ports ¹⁾

¹⁾ Crossporting bridges are approved for a maximum operating pressure of 100 bar; crossporting bridge also available for 3 outlets, see brochure

NOTE

Further technical information, technical drawings, accessories, spare parts or product function descriptions available on SKF.com/lubrication:

14389 EN; 951-230-013



3D

skf-lubrication.partcommunity.com/3d-cad-models

Progressive metering device

PSG3

Identification code	PSG3					X	
Product series							
Monitoring	<p>X = none 3 = 3-pin piston detector, M12x1 plug Y = cycle indicator, visual plunger rod ¹⁾ S = cycle indicator with bracket and proximity switch ¹⁾ G = cycle indicator with bracket for proximity switch (without proximity switch) ¹⁾</p>						
Position of monitoring device ²⁾	<p>X = none A = left, section 1 B = right, section 1 C = left, section 2 D = right, section 2 E = left, section 3 F = right, section 3 G = left, section 4 H = right, section 4 J = left, section 5 K = right, section 5 L = left, section 6 M = right, section 6 N = left, section 7 P = right, section 7 Q = left, section 8 R = right, section 8 S = left, section 9 T = right, section 9 U = left, section 10 V = right, section 10</p>						
Attachments	<p>F = SP/SMB 8 flow limiter with nominal volume up to 1.56 l/min G = SP/SMB 8 flow limiter with nominal volume from 1.67 l/min K = gear-type flow indicator</p>						
Plug-in nozzle for flow limiter	<p>see PUB 14389 EN; p. 22</p>						
Connector baseplate inlet ²⁾	<p>X = none D = tube Ø12 mm B = tube Ø8 mm F = tube Ø16 mm C = tube Ø10 mm E = tube Ø15 mm</p>						
Sections	<p>... = to be configured in the section configurator below</p>						

Section configurator	—	—
Section (minimum 3 sections) ³⁾	<p>X = dummy section R = 1,60 cm³/cycle P = 0,80 cm³/cycle ⁴⁾ S = 2,40 cm³/cycle Q = 1,20 cm³/cycle T = 3,20 cm³/cycle</p>	
Outlet fitting left	<p>S = outlet closed by screw plug ⁵⁾ X = outlet without fitting</p>	
Outlet fitting right	<p>S = outlet closed by screw plug ⁵⁾ X = outlet without fitting</p>	

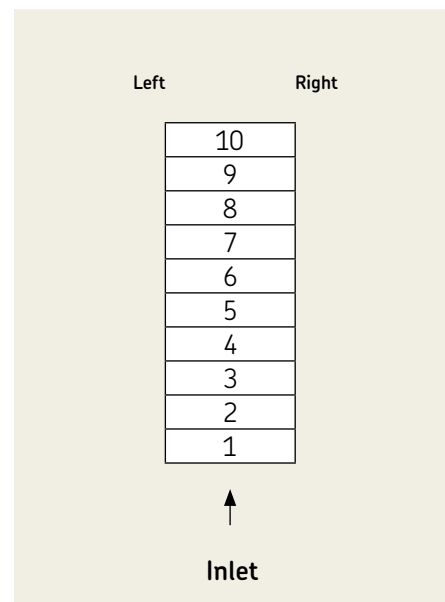

¹⁾ Installation on first or last section is not recommended
²⁾ Solderless pipe union with cutting sleeve per DIN 2353
³⁾ The volume per section is equal on both sides
⁴⁾ If possible, do not place in first position when designing metering device
⁵⁾ Metering device only operates with one side (left or right) outlet closed per section

Progressive metering device

VP



Description

The VP type metering device is a sectional metering device. Its metering sections cover a metering volume per outlet and cycle of 0,1 cm³ (T-section = 2 outlets) to 1,2 cm³ (S-section = 1 outlet). All sections (inlet, intermediate, end) are tightened via tie rods. The delivery ducts are sealed by porting plates in between the segments. A minimum of three intermediate sections is necessary.

Features and benefits

- Volumetric flow of up to 1,0 l/min; 2.1 pts/min
- Universal use in continuous or intermittent operation
- Metering sections with variable metering amount
- Internal and external consolidation of outlets
- Visual or electrical monitoring optional
- Ideal as main metering device
- All outlets with built-in, non-return valves

Applications

- Preferred master metering device
- Metal forming machines
- Vehicles, trucks
- Construction and mining
- Packaging machines
- General industry
- Farm machinery

Technical data

Function	sectional metering device
Outlets	6 to 20
Lubricant	grease up to NLGI 2; environmentally friendly mineral and synthetic oils; viscosity min. 12 mm ² /s
Metering quantity	per cycle and outlet: 0,1–1,2 cm ³ ; 0.006–0.073 in ³ 1 l/min; 2.1 pts/min
Flow rate	–25 to +90 °C; –13 to 194 °F
Operating temperature	oil: 200 bar: 2 900 psi
Operating pressure	grease: 200 bar; 2 900 psi
Material:	
inlet, separator and end plate	steel, galvanized/NBR
sections/piston plate	steel, galvanized
Inlet connection:	
VPM/VPG	M14 × 1,5 / G 1/4
Outlet connection:	
VPM/VPG	M10 × 1 / G 1/8
Protection class	IP 67
Dimensions	min. 98 × 82,5 × 41 mm max. 238 × 82,5 × 41 mm min. 3.86 × 3.25 × 1.61 in max. 9.37 × 3.25 × 1.61 in
Mounting position:	
on machines without vibration	any
on machines with vibration	piston position must be in 90° angle to machine's movement direction



NOTE

Further technical information, technical drawings, accessories, spare parts or product function descriptions available on SKF.com/lubrication:
15400EN, 951-230-008 EN



3D

skf-lubrication.partcommunity.com/3d-cad-models



Overview of oil circulation control units and software

Control units						
Product	Function type	Operating temperature max.		Electrical connection		Page
		°C	°F	V DC	V AC	
ST-2240-CIRC	Control unit	-20 to +70	-4 to +158	-	93–132 / 5.4 A 186–264 / 2.2 A	80

Control and monitoring software				
Product	Function type	Metering device to be used with	Connection interface	Page
SKF Flowline Software	Software	SKF Flowline Monitor flow meters	USB or SKF Flowline HUB (LAN)	81

Control unit

ST-2240-CIRC



Description

The SKF Control Centre ST-2240-CIRC is a stand-alone controller for oil circulation lubrication systems. It comes with a touch screen and remote smart phone option. It is a flexible and cost-effective solution for controlling and monitoring oil circulation lubrication systems. It comes with an easy-to-use touch screen interface, machine interlocking and various communication protocol.

Features and benefits

- Automatic and manual pump change
- Control of output pressure, output oil temperature and oil reservoir heating and filter pressures
- Automatic cold start-up mode
- By-pass valve control

Applications

- Oil circulation lubrication systems
- Pulp and paper industry
- Metals industry
- Mining, mineral processing and cement plants
- Power plants

Technical data

Function	control unit
Operating temperature 1)	-20 to +70 °C; -4 to +158 °F
Power supply	93–132 VAC / 5.4 A 186–264 VAC / 2.2 A 47–63 Hz
Instrument power supply	Internal power supply 24 V DC / 10A
Display	5.7 TFT touch screen, 64k color
Ports	Ethernet for remote control via web browser or mobile app for Android and iPhone/iPad USB for log and trend memory Modbus TCP for DCS (data control system) interface
Control unit	SKF ST-105
Communication	2 Modbus ports for VFD and display communication RS232/CAN interface for Flowline monitor communication
Input	4 analog/digital 4...20 A 6 digital 10 mA
Output	8 digital 24V / 2A 2 relay outputs for alarm and interlocking
Protection class	IP 65
Dimensions	380 × 380 × 210 mm 14.96 × 14.96 × 8.27 in
Mounting position	vertical

ST-2240

Order number	Designation	Material
12380707	ST-2240-CIRC	painting steel
12380708	ST-2240-CIRC-HST	stainless steel
on request	ST-2240-SUMP	painting steel
on request	Power stack	painting steel



NOTE

Further technical information, technical drawings, accessories, spare parts or product function descriptions available on SKF.com/lubrication:

14257 EN

Software

SKF Flowline Software



Description

The SKF Flowline Software is designed as a stand alone monitoring software for SKF Flowline Monitor flow meters. It collects and processes information on current states of all connected flow meters and records trends. A detailed visualization enables the operator to track down each alarm signal from the factory view to the individual panel and flow meter. The software provides detailed information on each lubrication point.

Features and benefits

- Full overview of all connected flow meters
- Traceability down to the lubrication point
- Compatibility with Canbus, Modbus, Profibus, Profinet

Applications

- Pulp and paper industry
- Metals industry
- Mining, mineral processing and cement

SKF Flowline Software

Order number	Designation
13399500	Flowline Software Version 2 with Flowline Hub
13399510	Flowline Software Version 2 with Flowline Hub and Bus Gateway
13399520	Flowline Software Version 2 with USB interface
13399540	Flowline Software Version 2 with Ethernet interface
13399560	Flowline Software Version 2 with RS232 interface



Overview of oil circulation monitoring devices

Level switches

Product	Function type	Operating temperature max.		Electrical connection		Page
		°C	°F	V DC	V AC	
WS 32/33/35	level switch	-10 to +80	+14 to 175	230	230	84
WS-63-2	level switch	-10 to +80	+14 to 175	200	240	86
WS 68	level switch	-10 to +80	+14 to 175	48	48	86

Monitoring and indication devices

Product	Function type	Flow rate		Operating temperature max.		Electrical connection		Page
		l/min	pts/min	°C	°F	V DC	V AC	
171-210	flow monitor	0,05–14,0	0.10–29.58	+5 to 80	+41 to 176	-	250 / 0,5 A	88
SFZM	gear wheel indicator with pulse generator	0,09–8,0	0.19–16.90	-20 to 70	-4 to 158	10-30V DC	-	90
SFZ	gear wheel indicator hall sensor	6,00–180	12.7–380	0 to +70	+32 to 158	24 ±10%; 20 mA	-	92
IPM	digital pulse meter	-	-	-20 to 60	-4 to 140	24 ±2%	-	94

Level switch

WS 32/33/35



Description

Fill level switches monitor the fill level in non-pressurized fluid reservoirs. To meet different requirements, fill level switches either have one or two switching points. If fill level switches have one switching point (WS32), the minimum fill level in the reservoir is monitored. Fill level switches with two switching points either monitor the minimum and maximum fill levels in the reservoir so the filling stops automatically when the maximum level is reached (WS33), or they monitor the minimum fill level and have an early warning function (WS35). The latter version gives a signal before a critical oil level in the reservoir is reached so oil can be topped off before the machine stops working. Other fill level switches are available on request, e.g. with three switching points.

Features and benefits

- Easy mounting
- Different plug sizes
- Various switching points

Applications

- Machine tools
- Printing
- Automation

Technical data

Function	level switch
Lubricant	mineral and synthetic oils; viscosity max. 1 500 mm ² /s
Operating temperature	-10 to +80 °C; +14 to 175 °F
Material	Aluminium, CuZn, NBR, PP
Switching points :	
WS 32	1
WS 33, WS35	2
Switching element	reed contact
Switching voltage	230 V AC, 230 V DC
Switching capacity max.	60 VA / 40 W
Switching current max.	1 A
Switching point settings	100–1 600 mm; 3.94–63 in
Protection class	IP 65
Dimensions	
WS32	min. 100-1 600 × 52 × 52 mm min. 3.94-63 × 2 × 2 in
WS33	max. 120-600 × 52 × 52 mm max. 4.72-23.6 × 2 × 2 in
WS 35	max. 120-1 600 × 52 × 52 mm max. 4.72-63 × 2 × 2 in
Mounting position	vertical



NOTE

Further technical information, technical drawings, accessories, spare parts or product function descriptions available on SKF.com/lubrication:

1-1702-EN

Level switch

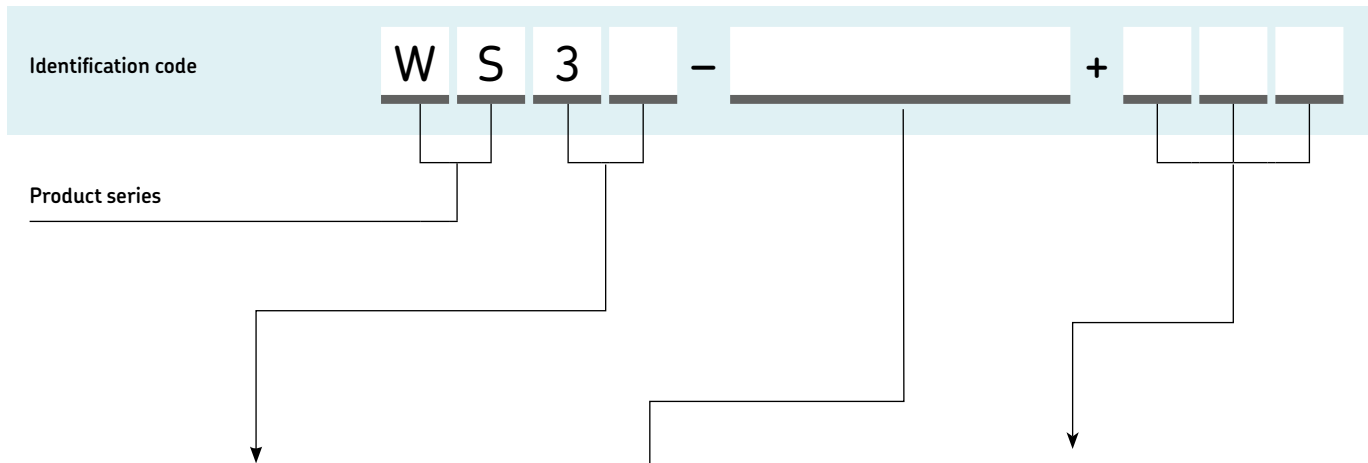
WS 32/33/35



Switching points ¹⁾

Code	Designation
32	Minimum fill level
33	Minimum and maximum fill levels
35	Early warning and minimum fill level

¹⁾ gasket included

Plug connector and visual monitoring

Code	Designation
S10	Circular connector with cable socket and LED
2	Square connector with cable socket, without LED
S30	Circular connector M12x1 with LED
2-V57-A	Circular connector x1 without LED

Lengths keys for fill level switch

Lenght mm	Designation	Lengths keys					
		WS32	WS33	WS33	WS33	WS33	WS35
		-	50	100	150	65	-
100	C49	-	-	-	-	-	-
110	C25	-	-	-	-	-	-
120	C17	V69	V69	-	-	-	C17
130	B27	Y72	Y72	-	-	-	B27
140	B97	X16	X16	-	-	-	B97
150	C08	X41	X41	Z06	-	-	C08
160	E08	X24	X24	-	-	-	E08
170	D84	X07	X07	-	-	-	D84
180	B53	X22	X22	-	-	-	B53
190	E77	Y91	Y91	-	-	-	E77
200	B31	V85	V85	Y87	-	-	B31
210	D42	ZE7	ZE7	-	-	-	D42
220	C52	V86	V86	-	-	-	C52
230	C81	V27	V27	-	-	-	C81
240	C79	Z49	Z49	-	-	-	C79
250	B44	X46	X46	V23	ZG4	-	B44
260	F01	Y69	Y69	-	-	-	F01
270	D54	ZL8	ZL8	-	-	-	D54
280	C04	X98	X98	-	-	-	C04
290	D65	X84	X84	-	-	-	D65
300	B37	X76	X76	V75	-	-	B37
325	E28	-	-	-	-	-	E28
350	B46	X86	X86	V21	-	-	B46
375	D13	-	-	-	-	-	D13
400	B95	V74	V74	V43	-	-	B95
425	D56	-	-	-	-	-	D56
450	L69	Y85	Y85	-	-	-	L69
475	E30	-	-	-	-	-	E30
500	B28	V49	V49	V17	Y77	-	B28
550	B48	-	-	-	-	-	B48
600	B51	-	-	X93	-	-	B51
650	C65	-	-	-	-	-	C65
700	F94	-	-	-	-	-	F94
750	E54	-	-	-	-	-	E54
800	F29	-	-	-	-	-	F29
850	F53	-	-	-	-	-	F53
900	L24	-	-	-	-	-	L24
1000	B70	-	-	-	-	-	B70
1100	B84	-	-	-	-	-	B84
1200	F49	-	-	-	-	-	F49
1300	F77	-	-	-	-	-	F77
1400	L06	-	-	-	-	-	L06
1500	F83	-	-	-	-	-	F83
1600	L34	-	-	-	-	-	L34

Level switch

WS63-2



Description

Fill level switches monitor the fill level in non-pressurized fluid reservoirs. To suit different requirements, the fill level switches either have one or two switching points. WS63-2 series has only one switching point and electric contact opens with dropping oil level. The switch can be turned by 180° to make the electric contacts close with rising oil level.

Features and benefits

- Compact design
- Dropping and rising oil level monitoring

Applications

- Machine tools
- Printing
- Automation

Technical data

Order number	WS63-2
Function	level switch
Lubricant	mineral and synthetic oils; viscosity max. 1 500 mm ² /s
Operating temperature	-10 to +80 °C; +14 to 175 °F
Material	PP, Aluminium, NBR
Switching voltage	240 V AC, 200 V DC
Switching capacity max.	100 VA / 50 W
Switching current max.	0,5 A
Switching points	1
Protection class	IP 65
Dimensions	55 × 55 × 131 mm 2.17 × 2.17 × 5.16 in
Mounting position	horizontal

 **NOTE**

Further technical information, technical drawings, accessories, spare parts or product function descriptions available on SKF.com/lubrication:

1-1702-EN

Level switch

WS68



Description

Fill level switches monitor the fill level in non-pressurized fluid reservoirs. To suit different requirements, the fill level switches either have one or two switching points. WS 68 series has only one switching point, and electric contact opens with dropping oil level.

Features and benefits

- Compact design
- Dropping and rising oil level monitoring

Applications

- Machine tools
- Printing
- Automation

Technical data

Order number	WS68
Function	level switch
Lubricant	mineral and synthetic oils; viscosity max. 1 500 mm ² /s
Operating temperature	-10 to +80 °C; +14 to 175 °F
Material	NBR, Aluminium, PA
Switching voltage	48 V AC/DC
Switching capacity max.	10 VA / 10 W
Switching current max.	0,25 A
Switching points	1
Protection class	IP 65
Dimensions	53 × 53 × 62 mm 2.09 × 2.09 × 2.44 in
Mounting position	horizontal



NOTE

Further technical information, technical drawings, accessories, spare parts or product function descriptions available on SKF.com/lubrication:

1-1702-EN

Flow monitor

171-210



Description

Flow monitors are minimum flow detector switches. They represent an inexpensive solution for the monitoring of smaller oil circulation lubrication systems or critical lubrication points in systems that generally are not equipped with individual flow monitoring.

Features and benefits

- Effective monitoring of minimum oil flow
- Wide flow range
- Available in five ranges but with identical outer dimensions
- High operating temperature

Applications

- Automotive industry
- Metal forming
- Machine tools
- Heavy industry

Technical data

Function	Flow switch
Lubricant	mineral oils; viscosity 20–1 000 mm ² /s ¹⁾
Flow rate	0,05–14 l/min; 0,10–29,58 pts/min
Operating temperature	+5 to 80 °C; +41 to 176 °F
Operating pressure ¹⁾	4–25 bar; 58–363 psi
Electrical connection	change-over 250 V AC / 0,5 A
Inlet connection	depending on model: M10×1, M18×1,5 M18×1,5
Outlet connection	
Material:	
Housing	die-cast zinc, polyamide
Seals	NBR (FKM on request)
Protection class	IP 65
Dimensions	min. 90 × 47 × 34 mm max. 101 × 47 × 34 mm min. 3.54 × 1.85 × 1.33 in max. 3.98 × 1.85 × 1.33 in
Mounting position	any

¹⁾ If the flow monitors are equipped with metering restrictors, at least 6 bars are required in the feed line

NOTE

Further technical information, technical drawings, accessories, spare parts or product function descriptions available on SKF.com/lubrication:

1-1704-EN, 951-170-232

Flow monitor

171-210

Flow monitor 171-210-05...

Order number	Flow rate		Connection	
	l/min	gal/min	inlet	outlet
171-210-051	0,05–0,1	0.01–0.03	M10×1	M18×1,5
171-210-052	0,1–0,2	0.03–0.05	M10×1	M18×1,5
171-210-053	0,2–0,5	0.05–0.13	M10×1	M18×1,5
171-210-054	0,5–0,8	0.13–0.21	M10×1	M18×1,5
171-210-055	0,8–1,8	0.21–0.48	M10×1	M18×1,5

Flow monitor 171-210-06...

Order number	Flow rate		Connection	
	l/min	gal/min	inlet	outlet
171-210-061	1,6–2,5	0.42–0.67	M18×1,5	M18×1,5
171-210-062	2,3–4,0	0.61–1.06	M18×1,5	M18×1,5
171-210-063	3,6–6,0	0.95–1.59	M18×1,5	M18×1,5
171-210-064	5,5–10,0	1.45–2.64	M18×1,5	M18×1,5
171-210-065	8,0–14,0	2.11–3.70	M18×1,5	M18×1,5

Connection fittings for 171-210-05...¹⁾

Inlet connection	Tube Ø	Union nut	Cutting ring	Adapter	Washer
mm					
M10×1	6	406-302	406-301	GD60.02	504-019
M10×1	8	408-302	408-301	GD80.02	-
M10×1	10	410-302	410-301	GD100.02	-

Connection fittings for 171-210-06...¹⁾

Inlet connection	Tube Ø	Functional nut
mm		
M18×1,5	12	460-212-001

Connection fittings¹⁾

Outlet connection	Tube Ø	Adapter
mm		
M18×1,5	6	223-13699-7
M18×1,5	8	473-808-392
M18×1,5	10	223-14293-2

¹⁾ Port tapped for solderless cutting-sleeve screw union to DIN 2353, connection piece without restrictor, straight screw-in connector

Gear wheel indicator

SFZM



Description

The SFZM gear wheel indicator is an oil flow monitoring device. It offers robust flow monitoring of lubrication points even under harsh environmental conditions. Its gear wheel measuring principle is based on the flow limiter technology. SFZM flow meters have a compact design and have small installation dimensions. At the same time, they allow a wide range of flow rates from 0,09 l/min to 8,0 l/min. This allows the use in a wide variety of applications. SFZM gear wheel indicators can also be used as monitoring device for self-adjusting circuits.

Features and benefits

- Compact and light weight design
- Corrosion resistant, robust aluminum body
- Three versions with different resolutions from 3, 6 to 12 ml/pulse
- Sight glass for visual monitoring
- Upper-level process control connectivity
- Atex design available on request

Applications

- Pulp and paper, metals industry
- Automobile body presses
- Mining and mineral processing



NOTE

Further technical information, technical drawings, accessories, spare parts or product function descriptions available on SKF.com/lubrication:

19278EN

Technical data

Function principle	gear wheel indicator
Lubricant	mineral and synthetic oils; viscosity 20 to 600 mm ² /s
Operating temperature	-20 to +70 °C; -4 to +158 °F
Operating pressure	max. 50 bar; max. 725 psi
Flow rate	0,09–8,0 l/min; 0.19–16.90 pts/min
Material	Al, Cu, Mg, Pb
Connection inlet	G3/8
Connection outlet	G3/8
Dimensions	
SFZM-X0...	63 × 69 × 93 mm; 2.48 × 2.71 × 3.66 in
SFZM-X1...	63 × 69 × 108 mm; 2.48 × 2.71 × 4.25 in
Weight	0,9 kg
Mounting position	any
Details pulse generator:	
Switch function	NO, PNP
Output type	inductive, 3-wire
Installation	flush-mounted
Sensing distance	4 mm
Secured sensing distance	0–3,24 mm
Switching frequency	max. 500 Hz
Operating voltage	10–30 V DC
Hysteresis	typ. 5%
Voltage drop	≤3 V
Operating current	0–150 mA
Residual current	0–0,5 mA, typ. 0,1 μA
Circuit state display	LED yellow
Protection class	IP 67
Short circuit protection	intermittent
Polarity reversal protection	yes
Plug connector	M12x1, 4-pin

Gear wheel indicator

SFZM

SFZ, gear wheel indicator

Order number	Designation	Monitoring	Resolution	Pulse	Connection (cable and plug) included	Cable length	
			ml/pulse	pulse/l		m	ft
6788-00000039	SFZM-X01XX-G	visual	3	333	–	–	–
6788-00000040	SFZM-X02XX-G	visual	6	167	–	–	–
6788-00000016	SFZM-X03XX-G	visual	12	83	–	–	–
6788-00000041	SFZM-X11XX-G	electrical	3	333	–	–	–
6788-00000042	SFZM-X12XX-G	electrical	6	167	–	–	–
6788-00000043	SFZM-X13XX-G	electrical	12	83	–	–	–
6788-00000001	SFZM-X11CS-G	electrical	3	333	cable with straight connector	2,00	6.56
6788-00000027	SFZM-X12CS-G	electrical	6	167	cable with straight connector	2,00	6.56
6788-00000012	SFZM-X13CS-G	electrical	12	83	cable with straight connector	2,00	6.56
6788-00000044	SFZM-X11CA-G	electrical	3	333	cable with angled connector	5,00	16.40
6788-00000045	SFZM-X12CA-G	electrical	6	167	cable with angled connector	5,00	16.40
6788-00000046	SFZM-X13CA-G	electrical	12	83	cable with angled connector	5,00	16.40
6788-00000047	SFZM-X11XS-G	electrical	3	333	straight connector	–	–
6788-00000048	SFZM-X12XS-G	electrical	6	167	straight connector	–	–
6788-00000017	SFZM-X13XS-G	electrical	12	83	straight connector	–	–
6788-00000049	SFZM-X11XA-G	electrical	3	333	angled connector	–	–
6788-00000050	SFZM-X12XA-G	electrical	6	167	angled connector	–	–
6788-00000051	SFZM-X13XA-G	electrical	12	83	angled connector	–	–

6788-00000046



2360-00000316



2360-00000317



Gear wheel indicator

SFZ



Description

The SFZ product series offers robust flow monitoring even under harsh environmental conditions. Its gear-wheel measuring principle is based on the flow limiter technology.

Features and benefits

- Three designs with metering ranges from 0 to 180 l/min (0 to 380 pts/min)
- Robust aluminium body
- Sight glass for visual monitoring
- Gear-wheel-type measuring principle

Applications

- Pulp and paper industry
- Metals industry
- Mining
- Mineral processing
- Cement
- Automobile body presses

Technical data

Function	gear wheel indicator
Lubricant	mineral and synthetic oils; viscosity 20–600 mm ² /s
Operating temperature ¹⁾	0 to +70 °C; +32 to 158 °F
Operating pressure	6–50 bar 87–725 psi
Flow rate	
SFZ 9E30/1:	6–30 l/min; 12.7–63.4 pts/min
SFZ 9E100/1:	25–132 l/min; 52.8–279 pts/min
SFZ 9E180/3:	max. 180 l/min; max. 380 pts/min
Electrical connection	hall sensor
Voltage	24 VDC ±10%; 20mA
Material	Al, Cu, Mg, Pb
Protection class	IP 65
Dimensions	min. 80 × 80 × 75 mm max. 190 × 180 × 150 mm min. 3.1 × 3.1 × 3.0 in max. 190 × 180 × 150 in
Mounting position	any



NOTE

Further technical information, technical drawings, accessories, spare parts or product function descriptions available on SKF.com/lubrication

Gear wheel indicator

SFZ

Order information

Order number	Designation	Monitoring	Connection	Flow rate	
				l/min	pts/min
24-2581-2155	SFZ 9E30/1	electrical	G 3/4	6–30	12.7–63.4
24-2581-2156	SFZ 9E100/1	electrical	G 1 1/4	25–132	52.8–279
24-2581-2550	SFZ 9E180/3	electrical	G 1 1/4	max. 180	max. 380

Pulse meter

IPM

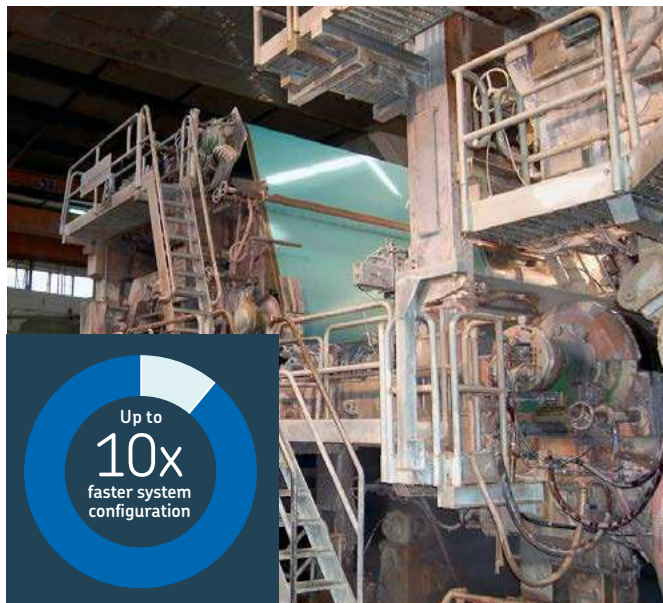

Description

IPM is a digital pulse metering panel to monitor flow rates in oil circulation systems. It can be operated combined with flow meters or flow limiters. The intuitive IPM touch display allows field configuration and individual parameters for up to 45 lubrication points. Each point is monitored against nominal flow value but can also have a reduced set point for startup period preventing unnecessary alarms. Besides informative local alarm messages, the panel offers five relay outputs with 15 different alarm combinations. Thanks to its modular design, IPM is optionally available with customized ethernet connections. IPM offers an excellent upgrade possibility for existing oil flow monitoring systems having pulse feed or static signals.

Features and benefits

- Easy wiring and installation
- Adjustable system start-up mode
- Upper-level process control connectivity
- Intuitive digital touch display with parameter set-up
- Real-time oil flow rate monitoring incl. alarm functions
- Excellent upgrade for existing pulse meter systems
- Compatible with SMD, SMB, SMBM and SFZM oil flow metering devices

Applications

- Pulp and paper industry
- Mining, mineral processing and cement industry
- Automotive industry
- Food and beverage
- Metals industry

Technical data

Function	digital pulse meter
Operating temperature	-20 to 60 °C; -4 to 140 °F
Connection type	0,5 ... 6 mm ² push-in
Electrical data	
Supply voltage	110VAC 60Hz / 230 VAC, 50Hz
Operating voltage	24 V DC ±2%
Power consumption	2 A
Ethernet options ¹⁾	Profinet, Profibus DP, OPC UA, etc.
Sensor types	PNP / NPN (2/3-wire sensor)
Amount of signal inlets	13, 29 or 45
Signal input types	pulse feed or static signals
Signal outputs	5× NO relays (potential free)
Switching voltage	max. 250 V AC/DC
Protection class	IP 65
Material	stainless steel 1.4404 (AISI 316L)
Dimensions	
IPM 13	550 × 200 × 175 mm 21.65 × 7.87 × 6.89 in
IPM 29	700 × 200 × 175 mm 27.55 × 7.87 × 6.89 in
IPM 45	900 × 200 × 175 mm 35.43 × 7.87 × 6.89 in
Mounting position	horizontal or vertical (depending on design)

¹⁾ Standard design with 5 digital alarm outputs.
Ethernet extensions like Profinet, Profibus or others on request.



NOTE

Further technical information, technical drawings, accessories, spare parts or product function descriptions available on SKF.com/lubrication
19286EN, 951-180-199-EN

Pulse meter

IPM

Order information

Order number	Designation	Electrical connection inlets	Dimensions	
			max.	mm
A765.78.001	IPM 13 horizontal ¹⁾	13	550 × 200 × 175	21.65 × 7.87 × 6.89
A765.78.004	IPM 13 vertical ¹⁾	13	200 × 550 × 175	7.87 × 21.65 × 6.89
A765.78.002	IPM 29 horizontal ¹⁾	29	700 × 200 × 175	27.55 × 7.87 × 6.89
A765.78.005	IPM 29 vertical ¹⁾	29	200 × 700 × 175	7.87 × 27.55 × 6.89
A765.78.003	IPM 45 horizontal ¹⁾	45	900 × 200 × 175	35.43 × 7.87 × 6.89
A765.78.006	IPM 45 vertical ¹⁾	45	200 × 900 × 175	7.87 × 35.43 × 6.89

¹⁾ Standard design with 5 digital alarm outputs. Ethernet extensions like Profinet, Profibus or others on request.



Mounting options

- Cabinet installation combined with SKF flow limiters e.g.
- Easy and flexible panel installation with optional legs, wall brackets or hood mounting frame
- Different standard panel sizes for up to 45 lubrication points
- Panel material is stainless steel AISI316
- Options: supply piping assembly, panel with cover and lock



Overview of oil circulation system accessories

Filters							
Product	Function type	Operating temperature max.		Filter rating	Operating pressure max.		Page
		°C	°F		bar	psi	
169-460-...	oil filter	-30 to +100	-22 to 212	3-50	100	1450	98
169-400-...	filter elements	-30 to +100	-22 to 212	3-50	30	435	98
176-200-...	dirt indicators	-30 to +100	-22 to 212	3-50	-	-	98

Filter

169-460-...



Description

SKF pressure filter series 169-460 are standard oil filters according to DIN 24550. They are modular in design with a filter housing (filter head/ filter body), a filter element and a screw plug. Optionally a dirt indicator can be selected instead of the screw plug. The pressure filters are used as line filters in the pipes of the CircOil lubrication system for separating solids from the fluids. Two kinds of filter elements are available. Fiberglass fleece – disposable elements based on inorganic fibers (absolute filtration) or wire fabric (nominal filtration). The dirt indicator monitors the filter element and signals when it needs to be replaced.

Features and benefits

- Prevents system or component failures and extends system life due to significant reduction of solids
- Economical, reliable and maintenance-friendly operation
- Compact and modular design mountable directly into pipes
- Wide range of volumetric flow up levels and grades of filtration
- Optimized service handling by replacing of filter elements only
- Dirt monitoring of filter elements as an option

Applications

- General mechanical and plant engineering
- Shipbuilding and offshore industry
- Pulp and paper industry
- Heavy industry

Technical data

Function	oil filter
Lubricant	mineral and synthetic oils; viscosity 20–1 000 mm ² /s
Operating temperature	-30 to +100 °C; -22 to 212 °F
Operating pressure	max. 100 bar max. 1450 psi
Pressure difference:	
Fiberglass fleece	Δp 30 bar; 435 psi
Dirt indicators	Δp 5 bar; 72.5 psi
Collapse pressure resistance:	
Fiberglass fleece	20 bar; 290 psi
Wire fabric	30 bar; 435 psi
Volumetric flow up	40 l, 63 l, 100 l; 10.6, 16.6, 26.4 gal
Filter ratings	3 to 50 μm
Material:	
Housing	Aluminum
Sealing material	FKM
Filter	Fiberglass fleece-inorganic-absolute filtration, wire fabric-stainless steel-nominal filtration
Connecting thread (ISO 228)	G 1/2
Dimensions	min. 92 × 82 × 186 mm max. 92 × 82 × 426 mm min. 3.62 × 3.3 × 7.32 in max. 3.62 × 3.3 × 16.77 in
Mounting position	vertical



NOTE

Further technical information, technical drawings, accessories, spare parts or product function descriptions available on SKF.com/lubrication:

1-0116-EN; 1-0103-EN

Filter

169-460-...

Filter complete	Volumetric flow		Filter element	Filter rating	Dirt retention		Filter material	Dirt indicator, display	Housing
	l	gal			µm	g			
169-460-261	40	10.6	169-400-260-V57	3	5,2	-	Fiberglass fleece	176-200-012	853-880-011
169-460-269	40	10.6	169-400-260-V57	3	5,2	-	Fiberglass fleece	833-030-014	853-880-011
169-460-273	40	10.6	169-400-260-V57	3	5,2	-	Fiberglass fleece	176-200-013	853-880-011
169-460-279	40	10.6	169-400-260-V57	3	5,2	-	Fiberglass fleece	176-200-014	853-880-011
169-460-280	40	10.6	169-400-260-V57	3	5,2	-	Fiberglass fleece	176-200-011	853-880-011
169-460-262	40	10.6	169-400-250	10	6,3	-	Fiberglass fleece	176-200-012	853-880-011
169-460-266	100	26.4	169-400-254	10	18,6	-	Fiberglass fleece	176-200-012	853-880-013
169-460-270	40	10.6	169-400-250	10	6,3	-	Fiberglass fleece	176-200-014	853-880-011
169-460-274	40	10.6	169-400-250	10	6,3	-	Fiberglass fleece	176-200-013	853-880-011
169-460-287	40	10.6	169-400-252	10	11,1	-	Fiberglass fleece	176-200-014	853-880-012
169-460-286	63	16.6	169-400-286	20	-	-	Fiberglass fleece	176-200-013	853-880-012
169-460-263	40	10.6	169-400-255	25	7	-	Fiberglass fleece	176-200-012	853-880-011
169-460-265	63	16.6	169-400-253	25	12,8	-	Fiberglass fleece	176-200-012	853-880-012
169-460-271	40	10.6	169-400-255	25	7	-	Fiberglass fleece	833-030-014	853-880-011
169-460-278	40	10.6	169-400-255	25	7	-	Fiberglass fleece	176-200-013	853-880-011
169-460-288	63	16.6	169-400-253	25	12,8	-	Fiberglass fleece	176-200-010	853-880-012
169-460-284	40	10.6	169-400-185-V57	25	-	440	Wire fabric	176-200-014	853-880-011
169-460-259	40	10.6	169-400-251	50	-	440	Wire fabric	833-030-014	853-880-011
169-460-272	40	10.6	169-400-251	50	-	440	Wire fabric	176-200-013	853-880-011
169-460-282	40	10.6	169-400-251	50	-	440	Wire fabric	176-200-009	853-880-011

Dirt indicators				
Order number	Indication	Switching type	Electrical connections	Switching points
176-200-009	Electrical/Optical	1x NO-contact / 1x NC-contact	M12x1 / 4-pin	75% / 100%
176-200-010	Electrical/Optical	1x NO-contact / 1x NC-contact	M12x1 / 4-pin / LED, Cold start suppression 30°C	75% / 100%
176-200-011	Electrical/Optical	2x NC-contact	-	75% / 100%
176-200-012	Electrical/Optical	1x NO-contact / 1x NC-contact	-	75% / 100%
176-200-013	Optical	-	-	-
176-200-014	Electrical	Change-over contact	DIN EN 175301-803-A	-

Filter elements	
Order number	Designation
169-400-260-V57	3 µm; NG 40
169-400-257	3 µm; NG 63
169-400-250	10 µm; NG 40
169-400-252	10 µm; NG 63
169-400-254	10 µm; NG 100
169-400-286	20 µm; NG 63
169-400-185-V57	25 µm; NG 40
169-400-253	25 µm; NG 63
169-400-255	25 µm; NG 40
169-400-256	25 µm; NG 100
169-400-251	50 µm; NG 40

Filter accessories	
Order number	Designation
833-030-014	Closure plug
853-880-011	Filter housing, without reverse flow rate NG 40
853-880-012	Filter housing, without reverse flow rate NG 63
853-880-013	Filter housing, without reverse flow rate NG 100
881-280-050	Mounting bracket for 3-liter plastic and metal reservoir
881-280-044	Retaining plate for 6-liter plastic reservoir
881-290-270	Filter plate for 6-liter metal reservoir
881-290-271	Filter plate for 15-liter metal reservoir
881-290-272	Filter plate for 30-liter metal reservoir
881-290-273	Filter plate for 50-liter metal reservoir

Index

24-0404-2310	65	44-0758-2049	69	169-460-280	99
24-0404-2311	69	95-0034-0908	53	169-460-282	99
24-0404-2520	53	161-218-000	35	169-460-284	99
24-0404-2520	53	161-228-051	35	169-460-286	99
24-0404-2521	53	169-400-185-V57	99	169-460-287	99
24-0404-2521	53	169-400-185-V57	99	169-460-288	99
24-0712-6050	67	169-400-250	99	171-210-051	89
24-1072-2113	63	169-400-250	99	171-210-052	89
24-1072-2113	63	169-400-250	99	171-210-053	89
24-1072-2113	67	169-400-250	99	171-210-054	89
24-1072-2113	67	169-400-251	99	171-210-055	89
24-1072-2114	63	169-400-251	99	171-210-061	89
24-1072-2114	67	169-400-251	99	171-210-062	89
24-1072-2115	63	169-400-251	99	171-210-063	89
24-1072-2115	67	169-400-252	99	171-210-064	89
24-1503-2103	53	169-400-252	99	171-210-065	89
24-1882-2029	65	169-400-253	99	176-200-009	99
24-1882-2029	69	169-400-253	99	176-200-009	99
24-1882-2121	63	169-400-253	99	176-200-010	99
24-1882-2121	67	169-400-254	99	176-200-010	99
24-1882-2151	63	169-400-254	99	176-200-011	99
24-1882-2151	67	169-400-255	99	176-200-011	99
24-1883-2081	63	169-400-255	99	176-200-012	99
24-1883-3016	65	169-400-255	99	176-200-012	99
24-1883-3017	69	169-400-255	99	176-200-012	99
24-2151-3734	74	169-400-256	99	176-200-012	99
24-2151-3736	74	169-400-257	99	176-200-012	99
24-2151-3760	70	169-400-260-V57	99	176-200-012	99
24-2151-3760	72	169-400-260-V57	99	176-200-013	99
24-2151-3762	70	169-400-260-V57	99	176-200-013	99
24-2151-3762	72	169-400-260-V57	99	176-200-013	99
24-2151-3764	70	169-400-260-V57	99	176-200-013	99
24-2151-3764	72	169-400-260-V57	99	176-200-013	99
24-2581-2155	93	169-400-286	99	176-200-013	99
24-2581-2156	93	169-400-286	99	176-200-014	99
24-2581-2550	93	169-460-259	99	176-200-014	99
24-2581-2615	53	169-460-261	99	176-200-014	99
24-2581-2616	53	169-460-262	99	176-200-014	99
24-2581-2617	53	169-460-263	99	176-200-014	99
24-2581-2652-ZH	53	169-460-265	99	179-990-600	63
24-2581-2656-ZH	53	169-460-266	99	179-990-600	67
24-2581-2657-ZH	53	169-460-269	99	179-990-601	63
24-2581-2658-ZH	53	169-460-270	99	179-990-601	67
24-2581-2693	53	169-460-271	99	209-10617-3	53
24-9909-0178-ZH	53	169-460-272	99	223-13699-7	89
24-9909-0178-ZH	53	169-460-273	99	223-14293-2	89
24-9909-0179	53	169-460-274	99	242-016.00	51
24-9909-0179	53	169-460-278	99	242-024.00	51
44-0758-2049	65	169-460-279	99	242-025.00	51

Index

242-026.00	51	853-880-011	99	12380707.....	17
242-034.00	51	853-880-011	99	12380707.....	17
242-035.00	51	853-880-011	99	12380707.....	17
242-044.00	51	853-880-011	99	12380707.....	17
242-045.00	51	853-880-011	99	12380707.....	17
242-054.00	51	853-880-011	99	12380707.....	17
242-055.00	51	853-880-011	99	12380707.....	17
242-056.00	51	853-880-011	99	12380707.....	17
242-064.00	51	853-880-011	99	12380707.....	17
242-065.00	51	853-880-012	99	12380707.....	17
242-104.00	51	853-880-012	99	12380707.....	17
242-124.00	51	853-880-012	99	12380707.....	17
242-146.00	51	853-880-012	99	12380707.....	17
406-162.....	51	853-880-012	99	12380707.....	17
406-301.....	89	853-880-013	99	12380707.....	17
406-302	89	853-880-013	99	12380707.....	80
408-162.....	51	881-280-044	99	12380708	80
408-211.....	51	881-280-050	99	13101037.....	19
408-301.....	89	881-290-270	99	13101038.....	19
408-302	89	881-290-271.....	99	13101039.....	19
410-018.....	51	881-290-272.....	99	13101042.....	19
410-162.....	51	881-290-273	99	13101043.....	19
410-301.....	89	6788-00000001.....	91	13101044.....	19
410-302.....	89	6788-00000012.....	91	13120180.....	57
412-011.....	51	6788-00000016.....	91	13120182.....	57
412-018.....	51	6788-00000017.....	91	13120202.....	57
460-212-001	89	6788-00000027.....	91	13120204.....	57
466-419-001.....	70	6788-00000039.....	91	13120206.....	57
466-419-001.....	72	6788-00000040.....	91	13120208.....	57
473-808-392.....	89	6788-00000041.....	91	13120210.....	57
504-019.....	89	6788-00000042.....	91	13120212.....	57
508-108.....	74	6788-00000043.....	91	13120214.....	57
508-215-CU	51	6788-00000044.....	91	13120216.....	57
605-27545-1.....	41	6788-00000045.....	91	13120218.....	57
605-27546-1.....	41	6788-00000046.....	91	13120220.....	57
605-27547-1.....	41	6788-00000047.....	91	13120222.....	57
605-27548-1.....	41	6788-00000048.....	91	13120224.....	57
605-28166-1.....	41	6788-00000049.....	91	13120226.....	57
833-030-014	99	6788-00000050.....	91	13120228.....	57
833-030-014	99	6788-00000051.....	91	13120230.....	57
833-030-014	99	12380707.....	17	13120232.....	57
833-030-014	99	12380707.....	17	13120234.....	57
853-880-011	99	12380707.....	17	13120236.....	57
853-880-011	99	12380707.....	17	13120238.....	57
853-880-011	99	12380707.....	17	13120240.....	57
853-880-011	99	12380707.....	17	13120300.....	57
853-880-011	99	12380707.....	17	13120310.....	57
853-880-011	99	12380707.....	17	13120312.....	57
853-880-011	99	12380707.....	17	13120314.....	57

Index

13120316.....	57	13140912.....	19	13525002.....	17
13120317.....	57	13140913.....	19	13525002.....	17
13120318.....	57	13140925.....	19	13525002.....	17
13120319.....	57	13140926.....	19	13525002.....	17
13120320.....	57	13140928.....	19	13525002.....	17
13120330.....	57	13141098.....	17	13525002.....	17
13120331.....	57	13141099.....	17	13525002.....	17
13120334.....	57	13141100.....	17	13525002.....	17
13120336.....	57	13143400.....	17	13525002.....	17
13120337.....	57	13143410.....	17	13525004.....	17
13120338.....	57	13143420.....	17	13525004.....	17
13120339.....	57	13143430.....	17	13525004.....	17
13120342.....	57	13143450.....	17	13525004.....	17
13120344.....	57	13143460.....	17	13525004.....	17
13120346.....	57	13143461.....	17	13525004.....	17
13120348.....	57	13143462.....	17	13525004.....	17
13120350.....	57	13143463.....	17	13525004.....	17
13120352.....	57	13143464.....	17	13525004.....	17
13120354.....	57	13143465.....	17	13525004.....	17
13120356.....	57	13143466.....	17	13525006.....	17
13120358.....	57	13143467.....	17	13525006.....	17
13120360.....	57	13143468.....	17	13525006.....	17
13120362.....	57	13143469.....	17	13525210.....	17
13120364.....	57	13143470.....	17	13525210.....	17
13120366.....	57	13143471.....	17	13525210.....	17
13120368.....	57	13143472.....	17	13525220.....	17
13120370.....	57	13143473.....	17	13525220.....	17
13120372.....	57	13143474.....	17	13525220.....	17
13120374.....	57	13143475.....	17	13525220.....	17
13120376.....	57	13149108.....	19	13525220.....	17
13120378.....	57	13149128.....	19	13525220.....	17
13120380.....	57	13396100.....	19	13525220.....	17
13127800.....	57	13396105.....	19	13525220.....	17
13127802.....	57	13396140.....	19	13525220.....	17
13127804.....	57	13396160.....	19	13525600.....	17
13127808.....	57	13396180.....	19	13525600.....	17
13127810.....	57	13396200.....	19	13525600.....	17
13127810.....	57	13396220.....	19	13525600.....	17
13127812.....	57	13396240.....	19	13525600.....	17
13127816.....	57	13396260.....	19	13525600.....	17
13128390.....	55	13396320.....	19	13525600.....	17
13128395.....	55	13396340.....	19	13525600.....	17
13140901.....	19	13399500.....	81	13525600.....	17
13140904.....	19	13399510.....	81	13525600.....	17
13140906.....	19	13399520.....	81	13525600.....	17
13140907.....	19	13399540.....	81	13525600.....	17
13140908.....	19	13399560.....	81	13525600.....	17
13140909.....	19	13525002.....	17	13525600.....	17
13140911.....	19	13525002.....	17	13525600.....	17

Index

13525600.....	17	GD60.02.....	89	VD1-108	47
13525600.....	17	GD80.02.....	89	VD1-109	47
13525600.....	17	GD100.02.....	89	VD2-102	47
13525600.....	17	included	17	VD2-103	47
13525600.....	17	included	17	VD2-104	47
13525600.....	17	included	17	VD2-105	47
13525600.....	17	included	17	VD2-109	47
13525600.....	17	included	17	VD3-099	47
13525600.....	17	included	17	VD3-100	47
13602245.....	19	M1-2000+299.....	27	VD3-101	47
13608504	19	M2-2000+299.....	27	VD3-102	47
13772590.....	17	M2-2004+299.....	27	VD4-099	47
13772590.....	17	M2-2127+299	27	VD4-100	47
13772590.....	17	M2-S14+299	27	WS63-2.....	86
13772590.....	17	M5-2000+299.....	27	WS68	87
13772590.....	17	M5-2013+299.....	27	WVN200-10	35
13772590.....	17	M5-2024+299.....	27	ZM12-21+1GD	33
13772590.....	17	M5-S12+299	27	ZM12-21-S11+1GD.....	33
13772590.....	17	M10-2002+299.....	27	ZM12-31+1GD	33
13772590.....	17	MF1-2000+299.....	27	ZM502+1GD.....	39
13772590.....	17	MF1-2006+299.....	27	ZM502-3+1GD.....	39
13772590.....	17	MF1-BW3-S20+1GD.....	13	ZM502-S2+1GD	39
13772590.....	17	MF1-KW3-S15+1GD.....	13	ZM505+1GD.....	39
13772590.....	17	MF2-2000+299.....	27	ZM505-3+1GD.....	39
13772590.....	17	MF2-2127+299.....	27	ZM505-S2+1GD	39
13772590.....	17	MF2-BW7+299	13	ZM1002+1GD.....	39
13772612	17	MF2-KW6-S8+299.....	13	ZM1002-S2+1GD	39
13772612	17	MF2-S12+299	27	ZM1005+1GD.....	39
13772612	17	MF5-2000+299.....	27	ZM1005-S2+1GD	39
A765.78.001	95	MF5-2014+299.....	27	ZM1035+1GD.....	39
A765.78.002	95	MF5-4012+1GD.....	27	ZM2101-2+1GD.....	39
A765.78.003	95	MF5-BW7+140	13	ZM2102-2+1GD.....	39
A765.78.004	95	MF5-BW16-S223+299.....	13	ZM2103+1GD.....	39
A765.78.005	95	MF5-BW51-S22+299G.....	13	ZM2103-2+1GD.....	39
A765.78.006	95	MF5-KW6+299	13	ZM2104-2+1GD.....	39
DIN908-R1-4-5.8.....	74	MF10-2001+299.....	27	ZM2201+1GD.....	39
DIN912-M6x45-8.8D2R.....	53	MF10-S12+1GD.....	27	ZM2202+1GD	39
DIN912-M6x45-8.8D2R.....	53	MF210-2001+299.....	27	ZP1.....	31
DIN912-M6x60-8.8D2R.....	53	SF05A.....	55	ZP1-S1.....	31
DIN912-M6x60-8.8D2R.....	53	SF10A.....	55	ZP12-2.....	31
DIN7603-A18x22-CU.....	51	SF15A.....	55		
FLM12-2000+299.....	29	SF20A.....	55		
FLM24-2000+299	29	SF30A.....	55		
FLMF12-2000+299.....	29	VD1-102	47		
FLMF12-BW3-2+299	15	VD1-103	47		
FLMF12-BW7+299	15	VD1-104.....	47		
FLMF12-BW16+299	15	VD1-105.....	47		
FLMF24-2000+299	29	VD1-106	47		
FLMF24-BW51-S2+MWZ.....	15	VD1-107.....	47		



Important information on product usage

SKF and Lincoln lubrication systems or their components are not approved for use with gases, liquefied gases, pressurized gases in solution and fluids with a vapor pressure exceeding normal atmospheric pressure (1 013 mbar) by more than 0,5 bar at their maximum permissible temperature.



skf.com | skf.com/lubrication

© SKF, RECONDOL and LINCOLN are registered trademarks of the SKF Group.

© SKF Group 2023

The contents of this publication are the copyright of the publisher and may not be reproduced (even extracts) unless prior written permission is granted. Every care has been taken to ensure the accuracy of the information contained in this publication but no liability can be accepted for any loss or damage whether direct, indirect or consequential arising out of the use of the information contained herein.

PUB LS/P1 18000 EN · February 2023

Certain image(s) used under license from Shutterstock.com